

VIP-5000 SERIES
VIDEO IMAGE PROCESSOR
OPERATION MANUAL
P1603

DD2773152
Rev 17
29 January 2021

FCC Statement

Supplier Declaration of Conformity (SDoC)

This product complies with Part 15 of the FCC Rules. Operation is subject to the following two conditions: (1) This device may not cause harmful interference, and (2) this device must accept any interference received, including interference that may cause undesired operation.

Note: This equipment has been tested and found to comply with the limits for a Class A digital device, pursuant to part 15 of the FCC Rules. These limits are designed to provide reasonable protection against harmful interference when the equipment is operated in a commercial environment. This equipment generates, uses, and can radiate radio frequency energy and, if not installed and used in accordance with the instruction manual, may cause harmful interference to radio communications. Operation of this equipment in a residential area is likely to cause harmful interference in which case the user will be required to correct the interference at their own expense.

Warning: The user is cautioned that changes and modifications made to the equipment without the approval of manufacturer could void the user's authority to operate this equipment.

Industry Canada Regulatory Information

This Class A digital apparatus complies with Canadian ICES-003.

Cet appareil numérique de la classe A est conforme à la norme NMB-003 du Canada.

Inquiries

Contact Daktronics with any questions regarding our product compliance.

Mail:

Daktronics
201 Daktronics Dr.
Brookings, SD 57006 USA

Phone:

800-325-8766

Website:

www.daktronics.com



Copyright © 2021

All rights reserved. While every precaution has been taken in the preparation of this manual, the publisher assumes no responsibility for errors or omissions. No part of this book covered by the copyrights hereon may be reproduced or copied in any form or by any means—graphic, electronic, or mechanical, including photocopying, taping, or information storage and retrieval systems—without written permission of the publisher.

Daktronics trademarks are property of Daktronics, Inc. All other trademarks are property of their respective companies.

Table of Contents

1 Introduction	1	Services	27
Daktronics Contact Information	1	Peripherals	28
Product Information	1	Light	29
First-Time Setup & Launch.....	2	Temperature	30
Access	2	Power Control	30
Display Connection	2	Run LED	31
Dashboard	2	Power Monitor	31
2 User Interface Basics	3	Door Switch	31
Interface Elements.....	3	Location.....	32
Right-Side Menu.....	4	Network Monitors.....	33
Settings	4	Diagnostics	34
Communication Settings	4	Fan Control.....	35
Monitoring Settings.....	4	PLR Fan Control	35
Secondary Calibration	4	Brightness Fan Control	35
Password Rules.....	5	Cabinet Fan Control	35
SSL Server	5	5 Monitor	36
Password	5	6 Stored Content	37
Help	5	Managing Stored Content Files	37
About	5	7 Troubleshooting	39
Legacy	5	Reset Controller	39
Main Menu	6	Logs	39
3 Dashboard	7	Save Logs	39
Dashboard Tiles.....	7	View Logs	39
4 Configuration	9	Display Hardware	40
Identification	10	Device	40
Input	11	Test to Run	41
DVI	11	Addresses to Test	43
Test Pattern	13	Enabled Ports	44
Stored Content	15	Power Control	46
Blank	15	Serial Loopback Test	46
Output.....	16	ISP	46
Brightness.....	18	Player	46
Brightness Limits	19	Display Face	46
Thermal Dimming Override	22	Aux	46
Network.....	23	Power Relay Control	47
Network	23	8 Calibration	48
IP Configuration	24	Module Adjustment.....	48
DNS Configuration	24	Camera	50
Proxy	24	Auto Blending	50
Network Test	25	9 System Backup	52
Time	26		

Table of Contents



10 Exchange/Repair & Return Programs	53
Exchange Program	53
Repair & Return Program.....	54
Shipping Address.....	54
Warranty & Limitation of Liability.....	54
11 Glossary	55
A Supplementary Documents.....	57
B Daktronics Warranty & Limitation of Liability.....	59

1 Introduction

This manual helps Daktronics customers operate a 5000 series Video Image Processor (VIP). Review the entire manual to understand all the features that the processor offers.

This manual assumes the user has a basic working knowledge of personal computer operations such as using menus and folders. Terms that describe commonly used computer operations are used frequently in this manual.

Daktronics Contact Information

Click **User**  in the upper-right corner then click **About** to open the support page with links to customer support services. This manual is accessible via the **Help**  button. Refer to **Right-Side Menu (p.4)**.

Reach Daktronics customer support online:

- www.daktronics.com/support

For further assistance, Daktronics Customer Service is available 7:00 a.m. to 7:00 p.m. CST, Monday to Friday via telephone.

- Domestic (U.S. and Canada): 1-800-325-8766
- International: +1-605-697-4000

Product Information

Daktronics video image processors are either stand-alone units (normally rack mounted), or embedded in the display cabinet itself. Refer to **Figure 1**.

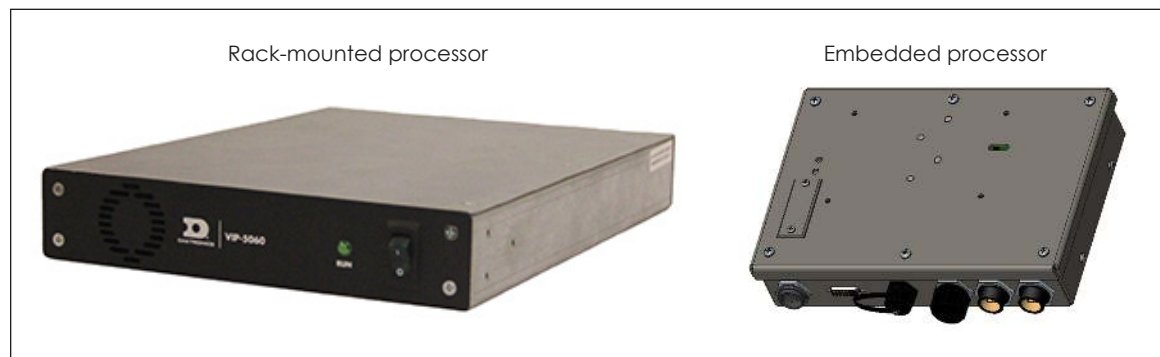

Figure 1: Processor Types

Figure 2 shows the rack-mounted VIP ports and **Figure 3** on the next page shows the embedded VIP ports.

For information on system hardware setup, refer to the **VIP-5000 Series Quick Guide (DD2773153)** in **Appendix A: Supplementary Documents (p.57)**.



Figure 2: VIP Ports (Rack-mounted Processor)

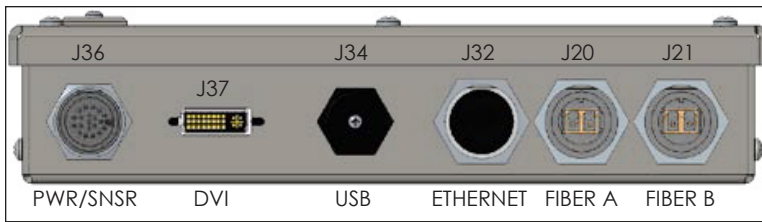

Figure 3: VIP Ports (Embedded Processor)

Several Daktronics products are based on the VIP-5000 series platform and much of the information in this manual is valid for the platform as a whole; however, specific products may differ. For information on the VIP-5150, refer to the standard Galaxy® GS6 series documentation.

First-Time Setup and Launch

Once physically connected, go to the processor's network address to run the configuration application stored within the device. The IP address is located in the documentation that arrived with the equipment or on the label on the back of the processor.

Refer to the **VIP-5000 Series Quick Guide (DD2773153)** in **Appendix A: Supplementary Documents (p.57)** for first-time login instructions.

Note: New customers receive the processor with a factory-determined IP address listed in the equipment documentation.

Access

While the VIP-5000 series runs on many different browsers and devices, use the latest versions of Google Chrome®, Mozilla® Firefox®, Microsoft® Internet Explorer®, or Apple® Safari® for the best experience.

Display Connection

Use the DisplayFind utility to find a device on a local network if the IP address is unknown. The computer running the DisplayFind utility must be on the same subnet as the target player. Refer to the **DisplayFind Utility Quick Guide (DD1961783)** in **Appendix A: Supplementary Documents (p.57)**.

Dashboard

After logging into the VIP, an initial **Dashboard** screen opens showing status tiles for various aspects of the device. For a general overview of the system interface, refer to **Interface Elements (p.3)**. For details on the dashboard, refer to **Section 3: Dashboard (p.7)**.

Click **Menu**  in the upper-left corner of the screen to expand the main menu. The main menu links are listed in **Main Menu (p.6)**. For more detailed information on each menu item, refer to **Section 3: Dashboard (p.7) – Section 9: System Backup (p.52)** in this manual.

2 User Interface Basics

Interface Elements

The VIP-5000 series processor interface includes elements that are always visible to the user, including a header bar, main menu, right-side menu, and main window. Refer to **Figure 4**.

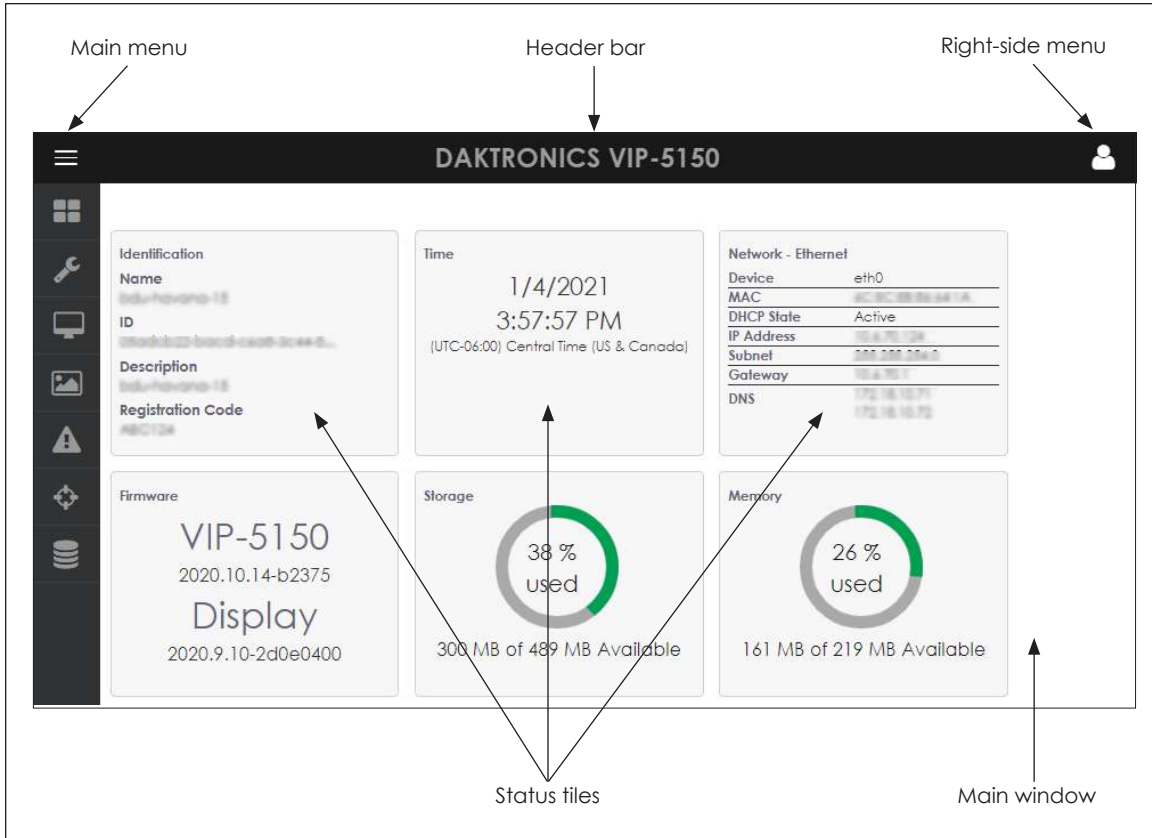









Figure 4: Interface Elements

- **Header bar** contains the application title across the top of the screen.
- **Right-side menu** is in the upper-right corner of the screen. Click **User**  to expand the menu panel to show the full session-specific navigation information. Refer to **Right-Side Menu (p.4)** for more information.
- **Main menu** is on the left side of the screen. Click **Menu**  in the upper-left corner of the screen to expand the menu panel to show the full navigation information. Refer to **Main Menu (p.6)** for more information.
- **Main window** displays elements, information, and data related to current user selections and system triggers. The example in **Figure 4** shows the initial **Dashboard** screen with status tiles in the main window.

Right-Side Menu

Click **User**  in the upper-right corner of the screen to expand the menu panel. Refer to the table below.

Menu Item	Description
 Settings	Opens the Settings window with options for changing several general system settings
 Password	Opens the Change Password window enabling a user to change the system password
 Help	Downloads an electronic version of this manual
 About	Opens a window showing Daktronics contact information and open source licenses and libraries used to build the VIP-5000 series processor
 Legacy	Opens a link to the previous VIP user interface in order to access a few legacy functions

Settings

Settings opens a window that enables the user to configure a number of general system settings. To change any of these values, enter the new value(s) and click **Save** at the top of the screen. Click **Cancel** to cancel any changes made before saving them. Click **Defaults** to restore the values to default settings. Refer to **Figure 5**.

Communication Settings

The **Timeout** field sets the length of time (in seconds) that passes before the VIP reports a connection problem. The server-client connection closes after this period of inactivity (timeout period). The default setting is 30 seconds.

The **Poll Interval** field sets how frequently the processor is polled for status information. This rate (in seconds) controls how often the dashboard is refreshed with new data. The default setting is 10 seconds.

Monitoring Settings

The **Limit** field controls how long (in seconds) the monitored output is shown when the **Monitor** tile is selected from the dashboard. The default setting is 180 seconds. Refer to **Monitor** under **Dashboard Tiles (p.7)**.

Secondary Calibration

This allows a user to adjust the components of each color for better color matching. Normally this setting is **Off**. Refer to **Module Adjustment (p.48)**.

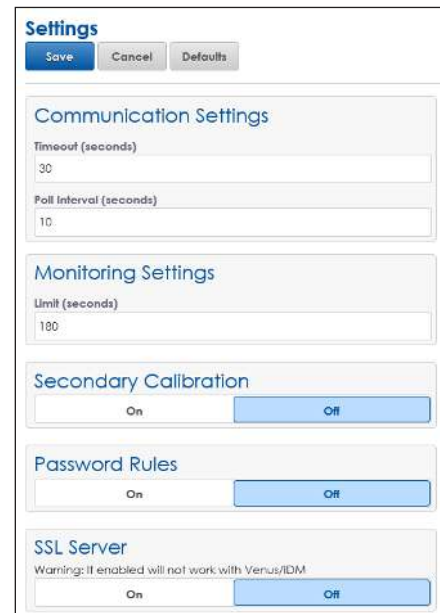

The screenshot shows the 'Settings' window with a title bar and three buttons: 'Save', 'Cancel', and 'Defaults'. The settings are organized into sections:

- Communication Settings:** 'Timeout (seconds)' is set to 30; 'Poll Interval (seconds)' is set to 10.
- Monitoring Settings:** 'Limit (seconds)' is set to 180.
- Secondary Calibration:** A toggle switch is currently set to 'Off'.
- Password Rules:** A toggle switch is currently set to 'Off'.
- SSL Server:** A toggle switch is currently set to 'Off'. A warning message below it reads: 'Warning: If enabled will not work with Venus/IDM'.

Figure 5: Settings

Password Rules

Turn this option **On** to enforce the following password rules:

- Passwords must be at least eight characters in length and contain at least three of the following four elements: special characters, letters, numbers, combination of upper-case and lower-case letters.
- Passwords can be changed only once per day.
- Passwords must be changed every 90 days.
- Passwords cannot match any previously used 24 passwords.

Note: The default setting for the password rules is **Off**.

SSL Server

Turn this option **On** to enable a secure internet connection over an https port. When enabled, this feature uses a self-signed certificate. The default setting for the SSL Server is **Off**.

Note: Enabling SSL disables communication with IDM or Venus® Control Suite.

Password

Password enables the user to change their password. Password requirements depend on how the **Password Rules** are configured under **Settings**. Refer to **Password Rules (p.5)** and **Figure 6** and **Figure 7**.

Enter the new password and confirm the change. Click **Save** to save the changed password. Click **Cancel** to close the **Password** window without saving the new password and return to the dashboard. After a new password is saved, the user is logged out and returned to the login prompt. Log in again using the new password.

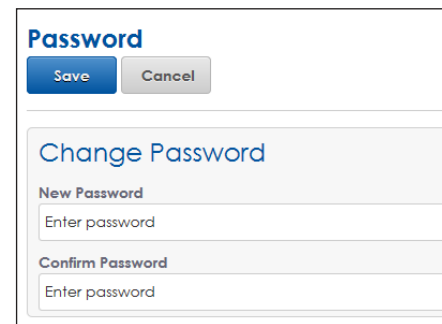

The screenshot shows a window titled "Password" with "Save" and "Cancel" buttons at the top. Below the title is a "Change Password" section with two input fields: "New Password" and "Confirm Password", each with the placeholder text "Enter password".

Figure 6: Password

Help

Help downloads a PDF version of this manual.

About

About opens a window with a link to the Daktronics website and the Daktronics customer support number. Click **Open Source attributions** for a listing of the open source libraries/licenses used to build the VIP-5000 series processor.

Legacy

Legacy opens the previous version of the VIP user interface in a new browser window. Within the legacy interface, click the help button  in the upper-left corner to access the legacy interface's manual.









The screenshot shows a window titled "Password" with "Save" and "Cancel" buttons at the top. Below the title is a "Change Password" section. It includes a warning: "The password can only be changed **once a day**. The password must have a **minimum of eight characters** and contain **at least 3** of the following:" followed by a bulleted list: "Special characters", "Alphabetical characters", "Numerical characters", and "Combination of upper case and lower case letters". Below this is another warning: "The password cannot match any of the previous 24 passwords used previously". At the bottom are two input fields: "New Password" and "Confirm Password", each with the placeholder text "Enter password".

Figure 7: Password with Rules Enabled

Main Menu

Click **Menu**  in the upper-left corner of the screen to expand the main menu panel to show the full system navigation information or hover over the icon to see the menu item name. Refer to the table below.

Menu Item	Description
 Dashboard	Shows status tiles for various aspects of the processor; some tiles only provide system information and others open menu functions
 Configuration	Lists all current configuration settings and tools including tools for setting the input, output, brightness levels, local time, and location
 Monitor	Opens a window showing a video feed of the display content
 Stored Content	Shows existing stored content files and allows images to be added or removed
 Troubleshooting	Lists troubleshooting options including resetting the controller, veiwing error logs, and testing
 Calibration	Lists calibration tools used to adjust individual modules to blend with surrounding modules
 System Backup	Saves the current system backup file or restores the system by uploading a saved backup file

For more detailed information on each main menu item, refer to **Section 3: Dashboard (p.7) – Section 9: System Backup (p.52)** in this manual.

3 Dashboard





Click **Dashboard**  to show the system status tiles. Standard status tiles are always visible; an **Important Messages** tile appears when an important configuration setting has been changed recently. Refer to **Figure 8**.









Figure 8: Dashboard Status Tiles

Dashboard Tiles

Most dashboard status tiles are interactive; click an interactive tile to open an operational window or menu item. The **Important Messages** tile and two other tiles (**Storage** and **Memory**) provide information only. When the cursor is placed over an interactive tile, the arrow changes to a hand symbol . If the tile is not interactive, the cursor remains as an arrow symbol. Clicking an open circle at the bottom of any tile opens another page of information within that tile.

- **Important Messages** - This tile warns the user that an important setting has changed. The number of important messages is indicated by the number listed at the top of the tile and the dots at the bottom of the tile. Refer to the **Important Messages** tile in **Figure 8**. Normally this tile is not present.
- **Identification** - This tile provides the processor's descriptive data including the name, ID number, description, and registration code. Click this tile to open **Identification** under the **Configuration**  menu.
- **Time** - This tile shows the current date, time, and time zone. Click this tile to open **Time** under the **Configuration**  menu.
- **Network-Ethernet** - This tile shows network device and address information. Click this tile to open **Network** under the **Configuration**  menu.
- **Firmware** - This tile shows the current version of VIP controller firmware and display firmware. Click this tile to open an operational window to update the VIP firmware. Normally, the **Boot load all devices** option is selected to update all devices at the same time. If troubleshooting a display, clear the **Boot load all devices** option to choose certain devices to be updated.
- **Storage** - This information tile shows how much file storage is currently being used and how much is available on the processor.

- **Memory** - This tile shows how much memory is currently being used and how much is available on the processor.
- **Brightness** - This tile shows brightness settings and current output. The **Configured** information shows how the brightness is determined and the brightness value that the processor is attempting to achieve. The **Current** information shows the actual brightness settings in use. Click this tile to open **Brightness** under the **Configuration**  menu.
- **Peripherals** - This tile provides information about any associated peripheral device(s). If more than one peripheral device is configured, the tile contains more than one page of information. Refer to the **Peripherals** tile in **Figure 8**. Click an open circle at the bottom of the tile to open information about another peripheral device. Click the tile itself to open **Peripherals** under the **Configuration**  menu.
- **Power Relay Control** - This tile provides information about the power relay controls that were configured under **Configuration > Peripherals**. Click this tile to open **Power Control** under the **Troubleshooting**  menu.
- **Input** - This tile provides details about the type of display input (**Display Mode**) that is currently being received by the display. Click this tile to open **Input** under the **Configuration**  menu.
- **Output** - This tile shows whether or not the display output state is currently active or inactive along with the display dimensions. Click this tile to open **Output** under the **Configuration**  menu.
- **Monitor** - This tile shows a thumbnail of the current display input or output. The content shown in this thumbnail is not a live video feed. Click this tile to open the **Monitor**  menu. Refer to **Section 5: Monitor (p.36)**. The image is shown for the length of time as defined under the **Right-side menu > Settings > Monitoring Settings > Limit**; refer to **Settings (p.4)**.

4 Configuration

Click **Configuration**  to open a configuration menu with a number of options. Refer to **Figure 9**. The currently selected link is underlined. In the example in **Figure 9**, **Identification** is selected.

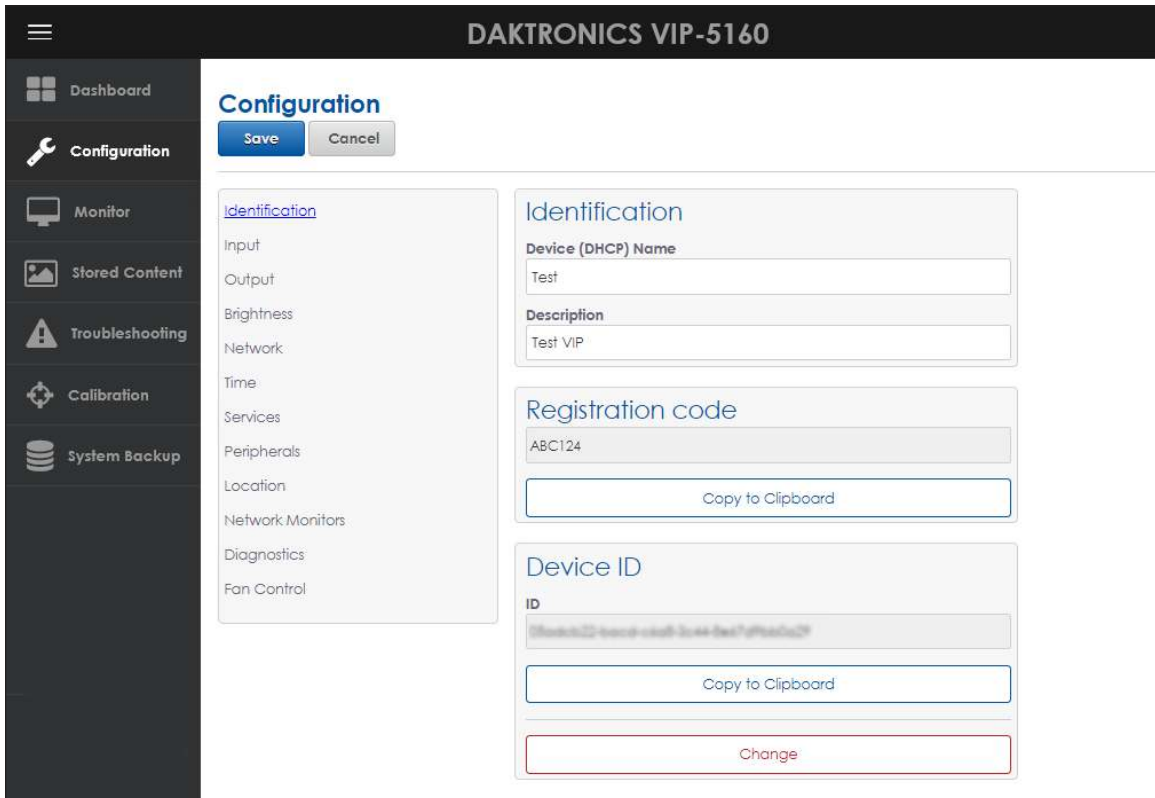

Figure 9: Configuration

After making a change to any configuration setting, save that change by clicking the **Save** button. If a change is made but not saved, an **Unsaved Changes** warning opens in a blue banner across the top of the screen. Refer to **Figure 10**.

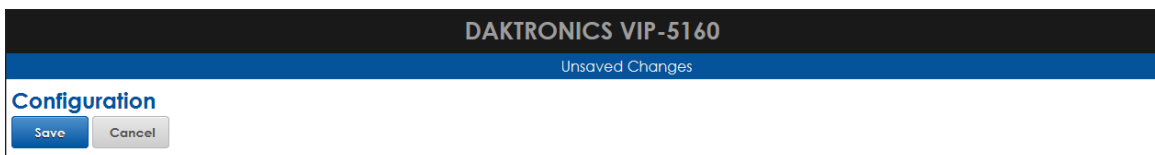

Figure 10: Unsaved Changes to Configuration Settings

Cancel any entered changes at any time before the change is saved. Click the **Cancel** button as shown in **Figure 10** to cancel the change and restore the previous information. A prompt opens to confirm that the change will be discarded.

After a configuration change is made and saved, a **Successfully updated configuration** message opens in a green banner across the top of the screen. Refer to **Figure 11**.

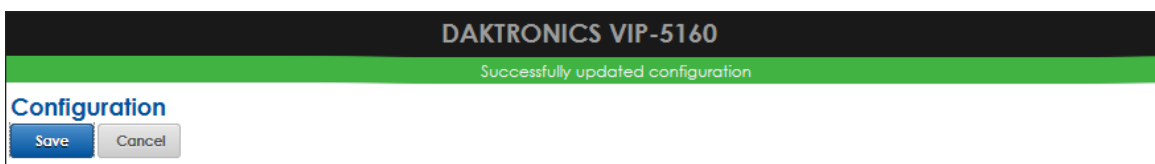

Figure 11: Changes Made to Configuration Settings

Input

Input configures the type of processor input with options for adjusting the color and how the signal is shown on the display. Refer to **Figure 13**.

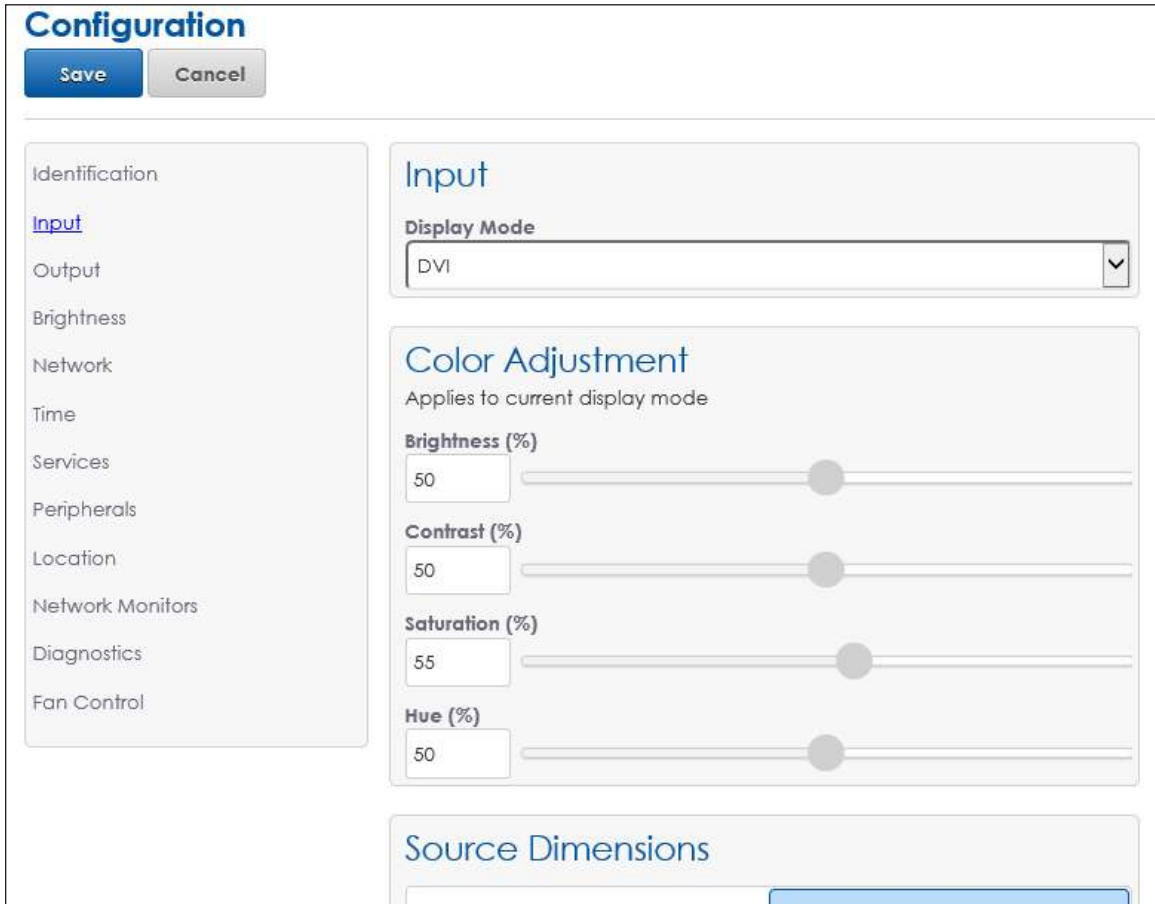

Figure 13: Configuration - Input

Select an input source from the **Display Mode** drop-down list: **DVI**, **Test Pattern**, **Stored Content**, or **Blank**. Refer to **Figure 14**.

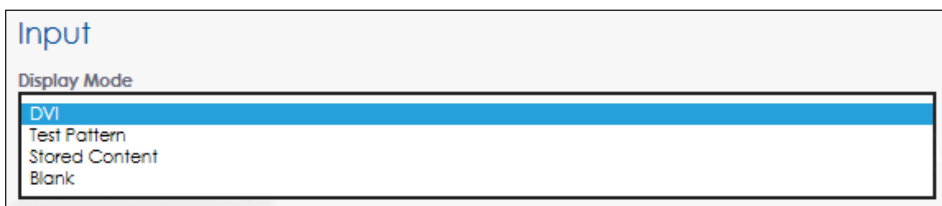

Figure 14: Input - Display Mode

DVI

Select **DVI** from the drop-down list to set the display input as an incoming DVI video signal. The processor must be connected to a video signal for the DVI display mode to function properly.

Change the **Color Adjustment** settings of the DVI video signal with the **Brightness**, **Contrast**, **Saturation**, and **Hue** sliders or by typing in the desired percentage values. Refer to **Figure 15** and the table below.

Figure 15: Input - Color Adjustment

Adjustment	Description
Brightness	Adjusts the overall gray level of the display. Increasing brightness makes blacks appear gray. Reducing brightness blackens low-level colors.
Contrast	Adjusts the difference between light and dark. A higher contrast creates a larger difference between dark and light areas. It can appear to improve the sharpness of the display, but it may remove the ability to discern between bright objects and cause low color depth.
Saturation	Adjusts the overall color composition of the video. Decreasing saturation makes colorful images gray. Increasing saturation makes colorful images more color rich, but can over-accentuate the colors of common objects. Over-saturated skin tones can appear redder.
Hue	Rotates color. Increasing the hue rotates colors (R→B, B→G, G→R); decreasing the hue rotates colors (R→G, G→B, B→R).

Configure the **Source Dimensions** as either **Automatic** or **Manual** to define what portion of the incoming video signal is shown on the display. If **Automatic** is chosen, the controller handles the content positioning, and the dimensions will match the configured display size. If **Manual** is chosen, the user manually defines the visible area. **Top** and **Left** define the beginning X and Y location on the display. **Height** and **Width** determine the size. Refer to **Figure 16**.

Figure 16: Input - Source Dimensions

Configure the **Target Dimensions** as either **Automatic** or **Manual** to position the incoming video signal on the display. With **Automatic**, the controller handles content placement and positioning and the dimensions will match the configured display size. With **Manual**, the user manually defines the content placement and positioning. Refer to **Figure 17**.

Note: Take care to avoid shifting the output from the display's viewable area.

Note: Do not use this feature unless instructed to do so by Daktronics technicians.

Figure 17: Input - Target Dimensions

Test Pattern

Test patterns are used during display installation, troubleshooting, and display operation when no video sources are available. Select **Test Pattern** from the **Display Mode** drop-down list to open the **Test Pattern** drop-down list.

Enter **0** in the **Minimum Hold Time (Seconds)** field and click the **Test Pattern** drop-down list to see the full list of available test patterns. The minimum hold time defines the time between pattern changes for tests that consist of multiple patterns. Some moving test patterns run at a set speed and are listed in the test pattern drop-down list only if the minimum hold time is configured to **0**. Refer to **Figure 18** and **Figure 19**.

Figure 18: Input - Test Pattern Display Mode

Figure 19: Test Patterns

After selecting a test pattern from the drop-down list, click **Save** to start the test pattern.

Note: Test patterns play immediately when selected, interrupt any currently playing video, and continue to run until the **Display Mode** is changed.

Change the **Color Adjustment** settings, the **Source Dimensions**, and the **Target Dimensions** as described in **DVI (p.11)**.

Refer to the following table for descriptions of all available test patterns.

Test Pattern	Description
Cycle All	Cycles through all test patterns
Module Locator	Displays an alternating pattern showing the row and then the column of each module
Module ID	Displays a pattern that numbers each display module
Module ID 48x48	Displays a module ID pattern rendered at 48x48 for non-square/non-matrix modules
Module ID 32x32	Displays a module ID pattern rendered at 32x32 for non-square/non-matrix modules
Module ID 16x16	Displays a module ID pattern rendered at 16x16 for non-square/non-matrix modules
Color Bars	Displays a pattern similar to SMPTE color bars
Gradient	Displays an alternating red, green, blue, and white pattern that scrolls from left to right across the display
Vertical Gradient	Displays an alternating red, green, blue, and white pattern that scrolls from top to bottom across the display
Diagonal Pattern	Displays scrolling red, green, and blue diagonal lines from left to right across the display
All On	Displays red, green, blue, and white on the entire display
All On Red	Displays red on every pixel of the display
All On Green	Displays green on every pixel of the display
All On Blue	Displays blue on every pixel of the display
All On White	Displays white on every pixel of the display
All Off	Displays black on the entire display as the LEDs are turned off
Even Vertical Bars	Displays an alternating red, green, and blue one-pixel-width line on every even column of the display
Odd Vertical Bars	Displays an alternating red, green, and blue one-pixel-width line on every odd column of the display
Even Horizontal Bars	Displays an alternating red, green, and blue one-pixel-width line on every even row of the display
Odd Horizontal Bars	Displays an alternating red, green, and blue one-pixel-width line on every odd row of the display
Even Diagonals	Displays an alternating red, green, and blue one-pixel-width line on every even diagonal of the display
Odd Diagonals	Displays an alternating red, green, and blue one-pixel-width line on every odd diagonal of the display

Test Pattern	Description
Rotate Columns	Displays scrolling red, green, and blue one-pixel-width vertical lines from left to right across the display
Rotate Rows	Displays scrolling red, green, and blue one-pixel-width horizontal lines from top to bottom across the display
Daktronics Logo	Displays an alternating red, green, and blue D and border on each display module
Calibration Corners	Displays a pattern of dots on the corners of every module to aid in field calibration
Calibration Half On	Displays a RGB sequence with reduced brightness for field calibration
Bit Test	Displays an alternating red, green, and blue pattern that fades in across the display

Stored Content

Select **Stored Content** from the drop-down list to use locally stored image files as the input source. Refer to **Section 6: Stored Content (p.37)** for supported image file types and instructions for uploading content. Stored content must be available for the **Stored Content** display mode to function. Refer to **Figure 20**.

The **Minimum Hold Time** sets how long the stored content is displayed.

The image shows a configuration window titled "Input". Inside, there is a "Display Mode" dropdown menu with "Stored Content" selected. Below it is a "Minimum Hold Time (Seconds)" input field containing the number "1".

Figure 20: Input - Stored Content Display Mode

Change the **Color Adjustment** settings, the **Source Dimensions**, and the **Target Dimensions** as described in **DVI (p.11)**.

Blank

Select **Blank** from the drop-down list to cause the display to show a blank output.

Output

Output configures the processor's output parameters including the output state, what is shown during system startup, and the translation table. Refer to **Figure 21**.

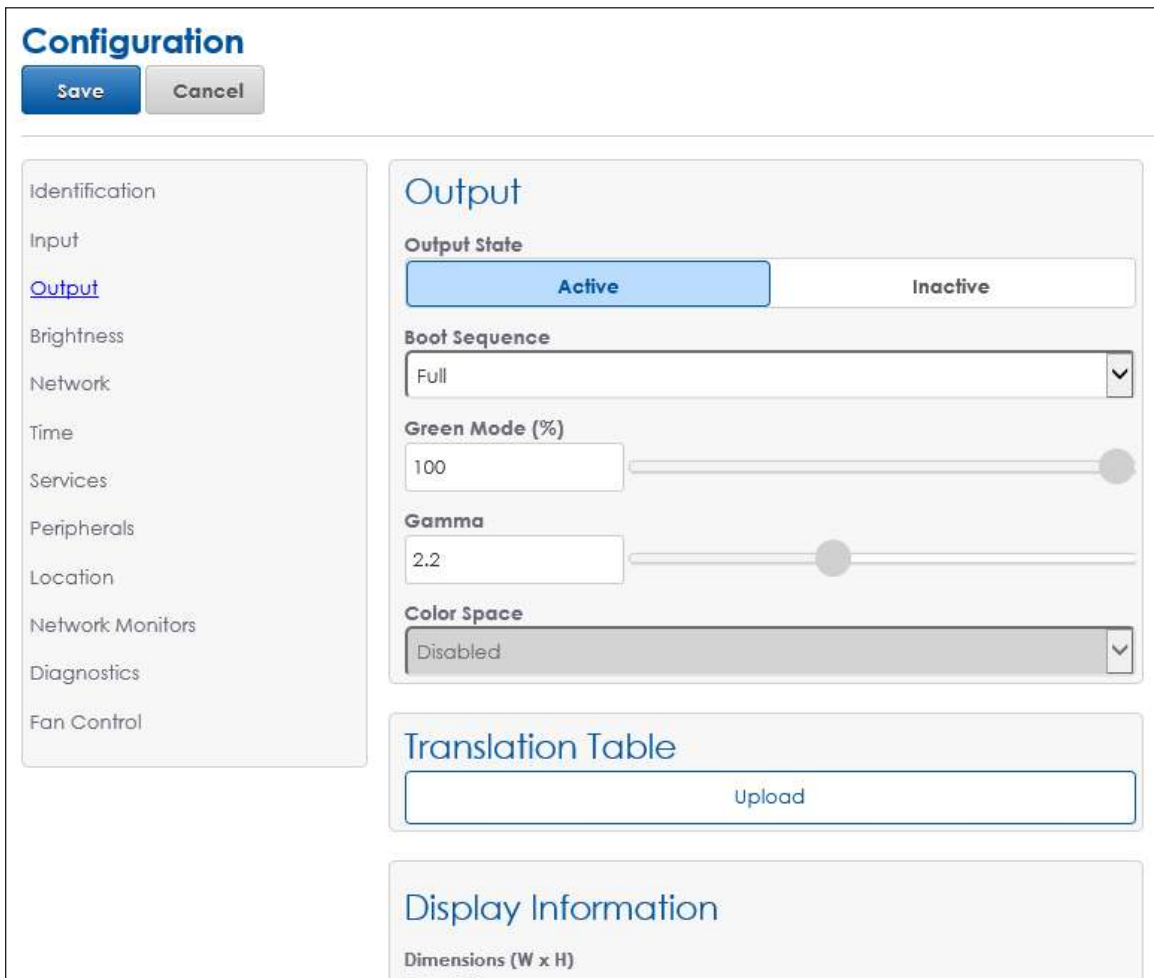

Figure 21: Configuration - Output

Output State sets the entire display output as **Active** or **Inactive**.

Displays can be configured to use primary and backup processor systems. If the processor system is the primary system, the **Output State** should be **Active**. If the processor system is the backup system, the **Output State** should be **Inactive**. Both primary and backup systems cannot be set as **Active** at the same time.

Note: If the **Output State** is **Inactive** and no backup system exists, the display will be blank.

If the **Output State** is **Active** and the display system has more than one face, set specific display faces as either **Active** or **Inactive**. This option may be used in a venue with a four-sided centerhung display where the three display faces facing the audience are **Active** and the fourth face (the one facing the performer) is **Inactive**. Refer to **Figure 22**.

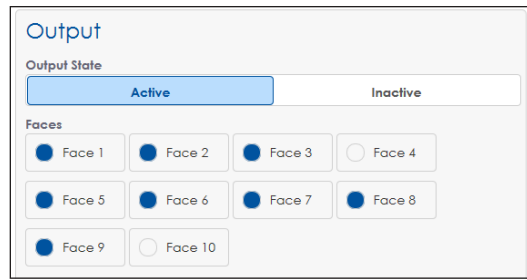

Figure 22: Output State - Multiple Faces

The **Boot Sequence** drop-down list selects what is shown during the display's startup procedure. Refer to **Figure 23**.



Figure 23: Boot Sequence Mode

- **Full** mode shows the description, display dimensions, color depth, time zone, list of communication services, firmware version, and the IP address. Playback begins after this is shown. **Full** is the default mode.
- **Compact** mode shows only product and version information. Playback begins after this is shown.
- **None** mode shows no information and playback starts immediately following start-up.

Use the **Green Mode** percentage field or slider to set a threshold for dimming the content shown on the display.

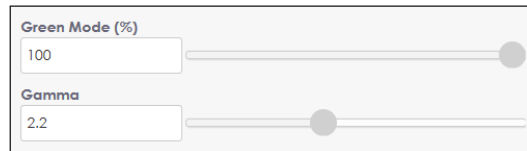

Figure 24: Output - Green Mode & Gamma

Use this option to conserve power by adjusting content dimming when it exceeds the maximum threshold limit. If full-motion video is displayed, this setting should be 100 percent. Refer to **Figure 24**.

The **Gamma** number field and slider adjusts the image's middle ranges of color but does not alter its full white or black values. The default value is **2.2**.

The **Color Space** setting changes the look of the display to match the selected video input color profile. HDTV/sRGB and Adobe RGB are common color profiles for computer sources. Other color profiles include NTSC, NTSC Obsolete, Adobe RGB, PAL, and Custom.



Figure 25: Output - Color Space

The default setting is **Disabled**. Color space settings may be modified with the **Custom** option. Refer to **Figure 25**.

Click **Upload** under **Translation Table** to upload a new translation table file. The translation table defines the display's internal component types as well as the internal wiring. Translation tables are normally factory-installed and vary based on display size and type. Refer to **Figure 26**.

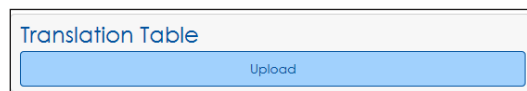

Figure 26: Output - Translation Table Upload

Contact Daktronics Technical Services to obtain the correct translation table.

Note: After uploading the translation table, the display output may be temporarily out of sync while the translation is applied.

The **Display Information** section provides information on the physical characteristics of the display. This information cannot be modified by the user. Refer to the table below and **Figure 27**.

Display Information	Description
Dimensions (W x H)	Width and height of the display's active area (in pixels)
Number of Faces	Number of display faces the controller is designed to operate
ED Number	Daktronics document number assigned to the translation table
Contract	Daktronics contract number for the equipment and installation (CXXXXX)
Title	Translation table name that includes the display series number, display size, pixel pitch, LED color, etc.
Date Created	Date the translation table was created

Display Information

Dimensions (W x H)
22 x 44

Number of Faces
10

ED Number
Not specified

Contract
Not specified

Title
16MT 10 Faces 20PLRs-P

Date Created
13:07:24 Mar 09 2011

Figure 27: Output - Display Information

Brightness

Brightness configures the brightness (or dimming) level of the display. Refer to **Figure 28**.

Configuration

Save
Cancel

- Identification
- Input
- Output
- Brightness
- Network
- Time
- Services
- Peripherals
- Location
- Network Monitors
- Diagnostics
- Fan Control

Brightness

Mode

Automatic
▼

In event of sensor failure

"Use Location" will use the location configured in the event of a sensor failure.

"Use Minimum" will use the minimum settings in the event of a sensor failure.

Use Location
Use Minimum

Brightness Limits

Set Brightness Settings

All Day
Day and Night

Minimum Brightness (%)

Maximum Brightness (%)

Thermal Dimming Override

Thermal Dimming Override disables thermal dimming for 10 minutes. Repeated use may cause equipment damage. Use only with guidance from Daktronics.

Override

Figure 28: Configuration - Brightness

Define how the brightness of the display is controlled with the **Mode** drop-down list. Refer to **Figure 29**.

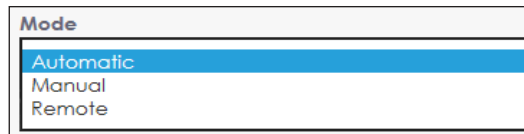

Figure 29: Brightness - Mode

- **Automatic** - Brightness values are determined by a light sensor and automatically adjusted according to ambient light conditions. Values vary to reflect the information received from the light sensor. During the day or in bright areas, display brightness will be the maximum set percentage. At night or in dim areas, the display brightness will be the minimum set percentage.

Note: There are two backup options in case of a light sensor failure. Choose **Use Location** for the brightness to automatically set to the maximum daytime level during the day or the minimum nighttime level during the night. Choose **Use Minimum** for the display to automatically set to the minimum brightness level configured under **Brightness Limits**.

- **Manual** - Brightness values are configured manually by using the slider or by entering a value in the field labeled **Manual level (%)**. The display will continue to run at this brightness level until changed by the user.
- **Remote** - Brightness values are configured within a host-client processor system. One VIP acts as the host and dictates the dimming level for the client systems. This dimming mode requires at least two VIP systems as well as a light sensor or VPMP (Video Processor Management Protocol) program to send dimming commands.

Brightness Limits

The settings under **Brightness Limits** determine the minimum and maximum brightness for either **All Day** (24-hours) or for the **Day and Night**.

The **All Day** option sets the display's minimum and maximum brightness for a 24-hour period by typing in percentage values or by using the sliders. Limits do not change based on time of day. Refer to **Figure 30**.

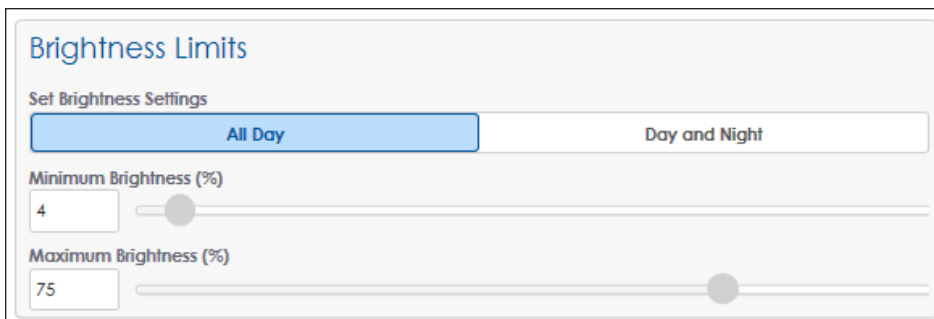

Figure 30: Brightness Limits

The **Day and Night** option sets the display's minimum and maximum brightness values based on the time of day. The time of day can be configured as either the sunrise/sunset times or by entering in specific times of the day. Click the **Day and Night** option under **Set Brightness Settings** to open a graph showing minimum and maximum brightness levels. These values are entered under the **Day** and **Night** sections as shown in **Figure 31** and **Figure 32**.

To configure the brightness limits based on the sunrise and sunset, the status file retrieves the sunrise/sunset times in HH:MM:SS. If this time cannot be retrieved, the firmware defaults to a value of 6:00 AM for sunrise and 9:00 PM for sunset.

Enter an offset time either before or after sunset/sunrise if desired. For example, the brightness level can be set to take effect 30 minutes before sunrise each day by entering **-30** in the Sunrise **Offset** field or 30 minutes after sunset each day by entering **30** in the Sunset **Offset** field.

The area between the red and blue lines on the graph in **Figure 31** shows the brightness values that the display can operate within.

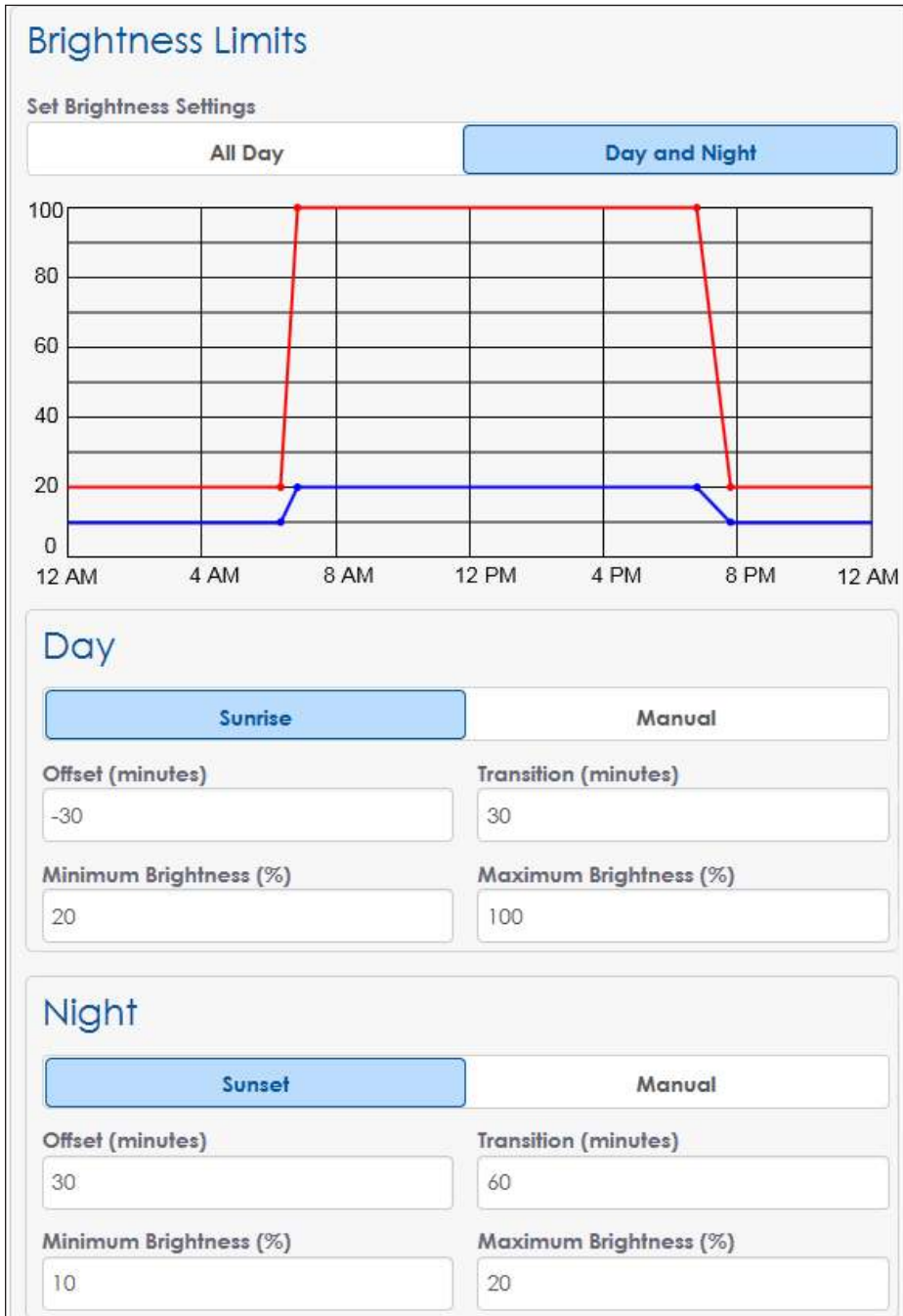

Figure 31: Brightness Limits - Day and Night, Sunrise and Sunset

Configure the transition time between brightness levels (how long it takes for the sign to change brightness levels between day and night settings). For example, **Figure 32** shows the transition from the 20% brightness level during the night to the maximum daytime brightness level of 100% will take 30 minutes. The transition from the 100% brightness level during the day to the maximum nighttime brightness level of 20% will take 60 minutes. This difference in transition time is shown in the graph.

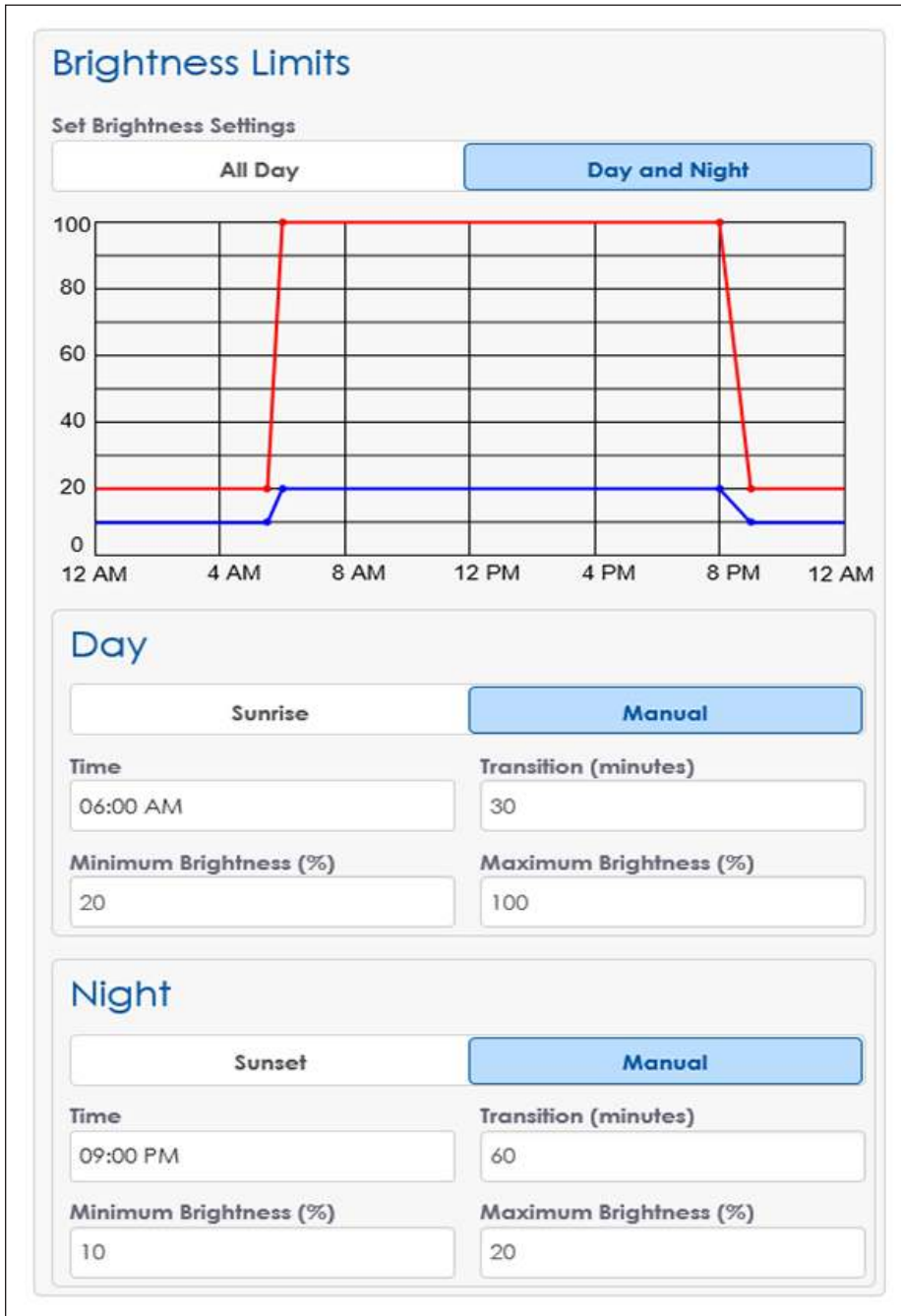

Figure 32: Brightness Limits - Day and Night, Manual

Note: Time-based dimming control depends on GPS coordinates. The interface will not allow time-based brightness limiters if GPS coordinates are not entered. To enter GPS coordinates, refer to **Location (p.32)**.

Thermal Dimming Override

The **Thermal Dimming Override** function disables the thermal dimming safeguard. Thermal dimming is triggered automatically during temperature extremes to preserve the life of a display's electrical components. Refer to **Figure 33**.

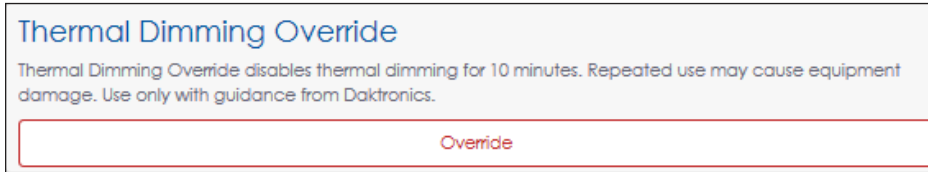

Figure 33: Thermal Dimming Override

The default thermal dimming trip point is set at 80 °C (176 °F) in the translation table. Dimming is triggered when display electronics reach or exceed this trip point. Once the display temperature falls below the trip point, the display brightness will increase to the original value.

The VIP uses an advanced algorithm to determine thermal dimming, but in rare cases, the VIP may enter or exit thermal dimming mode when the display temperature is slightly above or below the trip point.

When thermal dimming is active, a notice opens under the **Important Messages** tile in the **Dashboard** to warn the user of this state.

Use the **Thermal Dimming Override** feature to temporarily override the automatic dimming function during temperature extremes if the display becomes too dim for normal viewing. The override function times out after 30 minutes, and the display will begin to dim again if the temperature remains above the trip point.

Even if the override is activated, each component in the display also has a maximum allowable operating temperature; if this is exceeded, the component will blank itself. Components will automatically return to normal operation once the temperature falls into a safe range.

Note: Repeatedly using the **Thermal Dimming Override** or repeatedly increasing the trip point temperature may result in shortened display life or permanent damage to electronics and may void portions of the display warranty. Use the override function and increase the trip point only when instructed to do so by Daktronics technicians.

Network

Network sets the network configuration for the processor and tests the network connection. Configure both the Internet Protocol (IP) address and the Domain Name Server (DNS) address to communicate with the local area network (LAN). Refer to **Figure 34**.

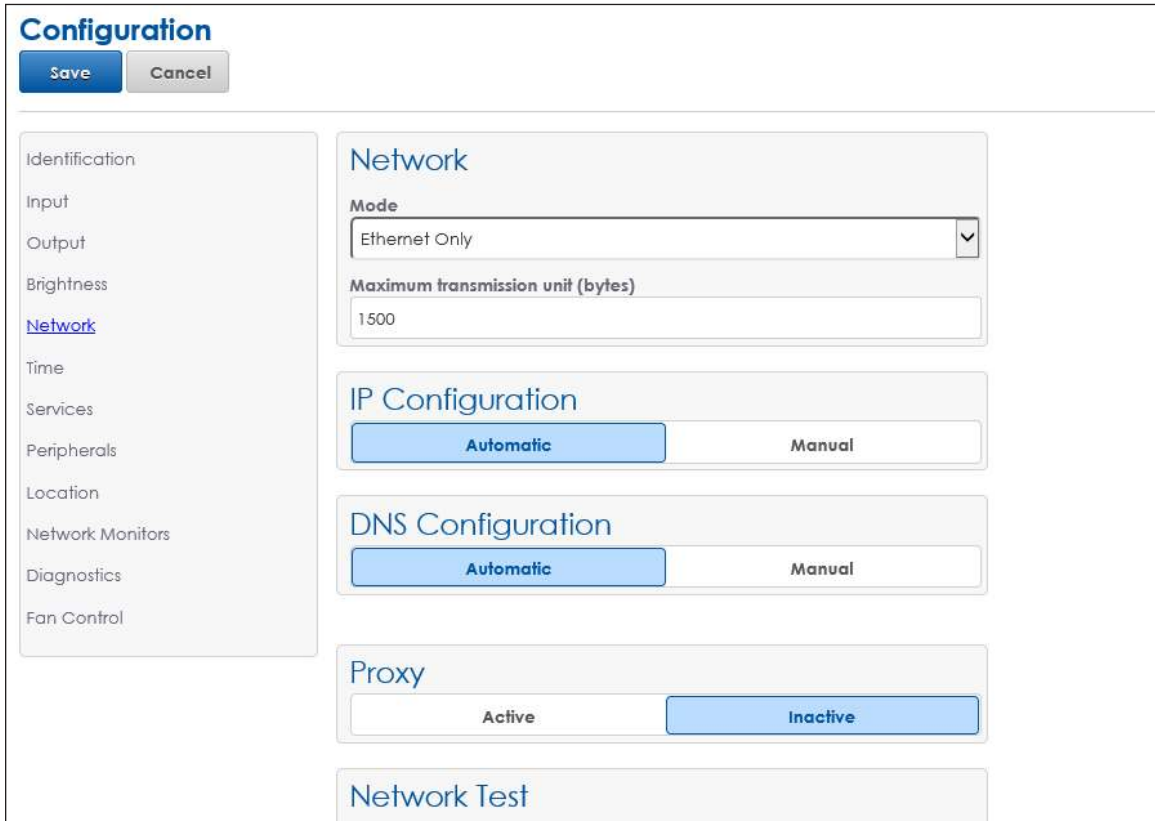

Figure 34: Configuration - Network

Network

Choose how the network is configured with the **Mode** drop-down list. Refer to **Figure 35**.

- **Ethernet Only** - The processor is not paired directly with a playback device such as a PC. The processor is the endpoint on the network and does not pass traffic to a connected device. This mode is typically used in standalone situations.
- **Ethernet-USB Bridge** - The processor passes all network traffic to a USB-connected device. Both the processor and USB-connected device appear as endpoints on the local network. This mode is typically used in billboard systems.
- **NAT** - The processor acts as a routing device to make a USB-connected device and the processor appear as one endpoint on a network.

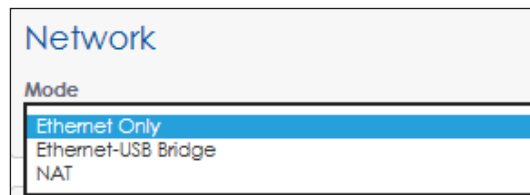

Figure 35: Network - Mode

Enter the **Maximum transmission unit** size for Ethernet communication in bytes (576-1500). The default is **1500**.

IP Configuration

Configure the Internet Protocol (IP) address either automatically or manually.

- **Automatic:** The Dynamic Host Configuration Protocol (DHCP) automatically assigns an IP address to the VIP. A DHCP server is required on the network for proper operation. If the network configuration is left in this mode and no DHCP server exists on the network, the address will default to **169.254.x.y**, where **x** and **y** will vary to assign a unique address on the network.
- **Manual:** The VIP is manually configured to use a specific IP address. Enter the **IP Address**, **Subnet**, and **Gateway** values manually when a DHCP server does not exist or when the installation requires the VIP to always use a static IP address. Refer to **Figure 36**.

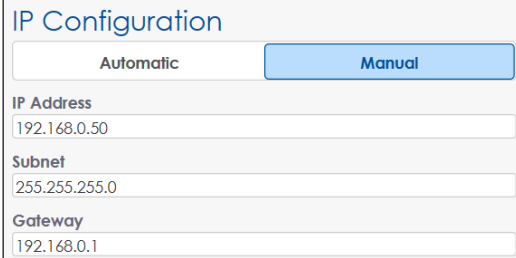

IP Configuration	
<input type="radio"/> Automatic	<input checked="" type="radio"/> Manual
IP Address	192.168.0.50
Subnet	255.255.255.0
Gateway	192.168.0.1

Figure 36: Network - IP Configuration

DNS Configuration

Domain Name Server (DNS) configuration is required to resolve host names for several services running on the VIP. Services such as diagnostics (IDM), control (Venus® Control Suite), and time servers require internet host names to be expressed in their dotted IP address format. An example of such a name resolution is the internet host name **www.daktronics.com** resolved to **64.233.169.147**.

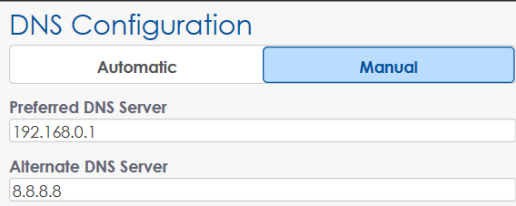

DNS Configuration	
<input type="radio"/> Automatic	<input checked="" type="radio"/> Manual
Preferred DNS Server	192.168.0.1
Alternate DNS Server	8.8.8.8

Figure 37: Network - DNS Configuration

Configure the DNS address either automatically or manually.

- **Automatic:** Information is received from a local Dynamic Host Configuration Protocol (DHCP) server to assign the address. To use this option, the **IP Configuration** also must be set to **Automatic**.
- **Manual:** The VIP is manually configured to use a specific DNS server on the internet or on the network. This option is used when a DHCP server is not available on the local network or the network administrator wants to use a specific DNS server. Enter a **Preferred DNS Server** (primary server) and an **Alternate DNS Server**. The VIP will query the alternate DNS server address in the event that the primary server does not respond. Refer to **Figure 37**.

Proxy

In systems with a proxy server, define the proxy host name and port number. Refer to **Figure 38**. Contact the local network administrator for more information.

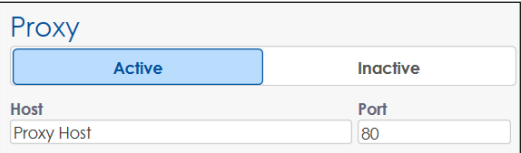

Proxy	
<input checked="" type="radio"/> Active	<input type="radio"/> Inactive
Host	Port
Proxy Host	80

Figure 38: Network - Proxy

- **Active:** Select **Active** to activate the proxy server. Enter the host name into the **Host** field and the proxy port into the **Port** field.
- **Inactive:** Select **Inactive** to inactivate the proxy server.

Network Test

Network Test is used to troubleshoot possible network issues. This tests the received and transmitted signals. **Network Test** tests the processor using information from the server, not the remote computer used for control. This is used for questions such as “Can the VIP connect to IDM?”. The default target address **fusion.daktronics.com** is the IDM URL. This URL may be changed to any target site. Choose the type of network test from the drop-down list. Refer to **Figure 39**.

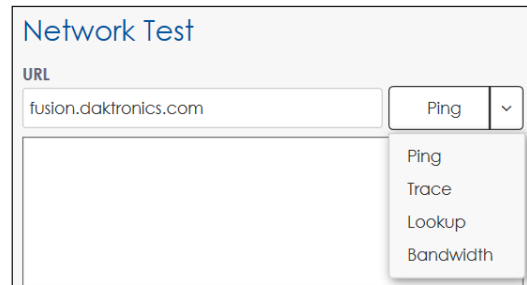

Figure 39: Network - Network Test

- Ping** - This test verifies successful communication between the control computer and the devices connected to it. The processor sends out a ping signal request to the target address and receives back a live output. The results of the test are listed as ping statistics in the main window. The results include the number of signal packets transmitted, the number of packets received, the percentage of packet loss, and the time it took for the signal packets to travel round-trip (minimum, average, maximum time). Refer to **Figure 40**.

```
PING fusion.daktronics.com (63.85.214.54): 56 data bytes
64 bytes from 63.85.214.54: seq=0 ttl=123 time=11.255 ms
64 bytes from 63.85.214.54: seq=1 ttl=123 time=10.334 ms
64 bytes from 63.85.214.54: seq=2 ttl=123 time=10.398 ms
64 bytes from 63.85.214.54: seq=3 ttl=123 time=10.135 ms

--- fusion.daktronics.com ping statistics ---
4 packets transmitted, 4 packets received, 0% packet loss
round-trip min/avg/max = 10.135/10.530/11.255 ms
```

Figure 40: Network Test - Ping

Note: Review the **Ping** test results with caution. If the target address has ping disabled, it cannot send back a response.

- Trace** - This test sends out a signal request to a target address and receives back information on how many hops the packet requires to reach the host and how long each hop takes. Refer to **Figure 41**.

```
traceroute to fusion.daktronics.com (63.85.214.54), 30 hops max, 38 byte packets
 1 192.168.0.1 (192.168.0.1) 1.082 ms 0.976 ms 0.784 ms
 2 10.0.61.1 (10.0.61.1) 1.323 ms 1.487 ms 4.604 ms
 3 66-17-99-145-swiffel.brookings.net (66.17.99.145) 9.727 ms 12.592 ms 9.085 ms
 4 66-17-96-226-swiffel.brookings.net (66.17.96.226) 9.509 ms 9.738 ms 12.882 ms
 5 gw1.daktronics.com (63.85.214.4) 12.772 ms 10.517 ms 10.209 ms
 6 63.85.214.54 (63.85.214.54) 11.787 ms * 11.133 ms
```

Figure 41: Network Test - Trace

- Lookup** - This test uses the configured DNS servers to look up the IP address of the specified domain name. Refer to **Figure 42**.

```
Server: 192.168.0.1
Address 1: 192.168.0.1 my.meraki.net

Name: fusion.daktronics.com
Address 1: 63.85.214.54
```

Figure 42: Network Test - Lookup

```
Running bandwidth test... 100% completed

Upload
Average: 5.95 Mbits/s
Max:10.28 Mbits/s

Download
Average: 341.89 Mbits/s
Max:682.67 Mbits/s
```

Figure 43: Network Test - Bandwidth

- Bandwidth** - This test sends and receives information from the remote computer to the processor. The test lists the average and maximum speeds for uploading and downloading data. Refer to **Figure 43**.

Time

Time sets the time zone for the processor, synchronizes the time, and configures the Network Time Protocol (NTP) servers. Refer to **Figure 44**.

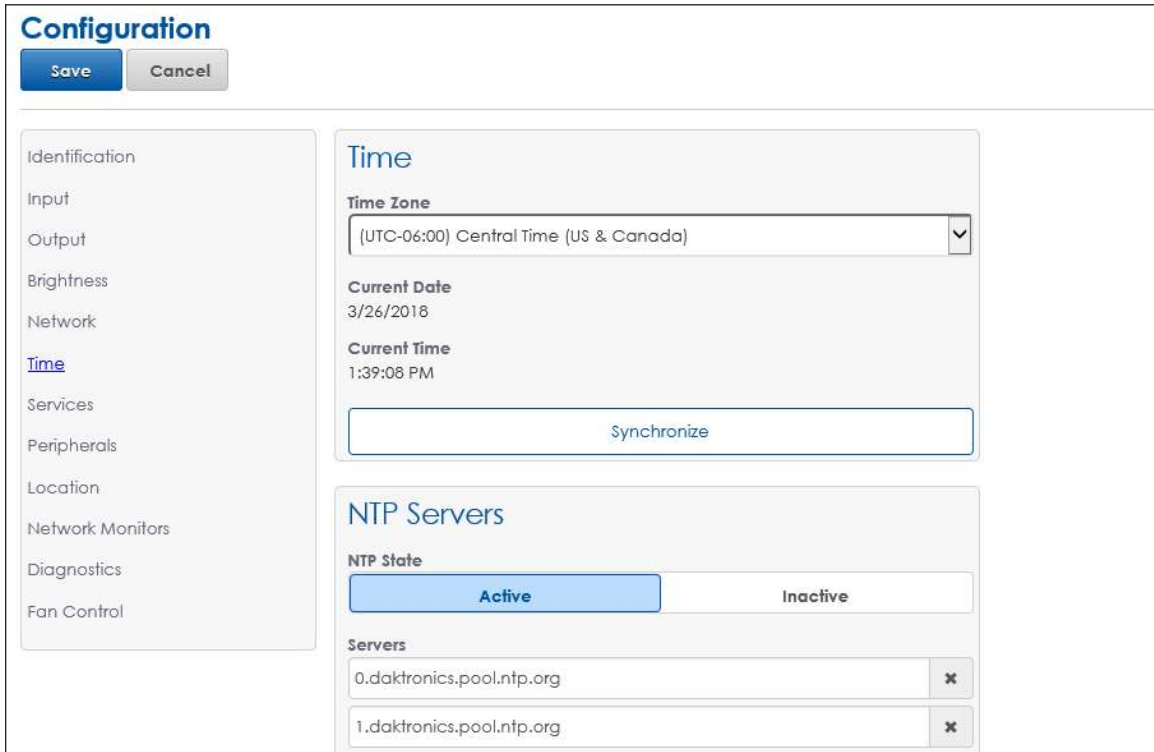

Figure 44: Configuration - Time

Use the **Time Zone** drop-down list to select the correct time zone for the display. The correct time zone is necessary for accurate astronomical brightness control and system log time stamps. The default time zone is **(UTC-06:00) Central Time (US & Canada)**.

Click the **Synchronize** button to synchronize the display's clock with the laptop's internal clock.

Network Time Protocol (NTP) servers synchronize the controller's clock with the selected time server. This setting is the default clock source and runs in the background to automatically maintain a precise time. The controller's network settings must be correct and the user must have access to the time server for this function to operate.

Set the NTP state as **Active** or **Inactive**. If the state is **Active**, two default addresses are used for synchronizing the time. Refer to **Figure 45**.

- The first address is the primary NTP server. The default address is **0.daktronics.pool.ntp.org**.
- The second address is the secondary NTP server. The default address is **1.daktronics.pool.ntp.org**.

These default addresses may be changed and additional NTP servers can be added by clicking the **Add Server** button.

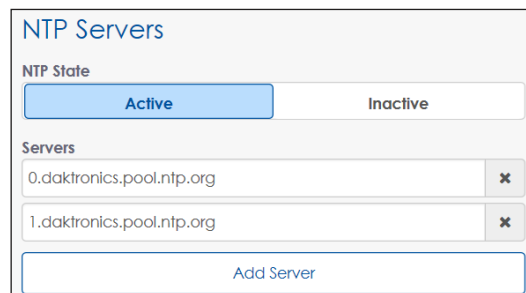

Figure 45: Time - NTP Servers

Services

Services configures the processor to communicate with other related software programs. Refer to **Figure 46**.

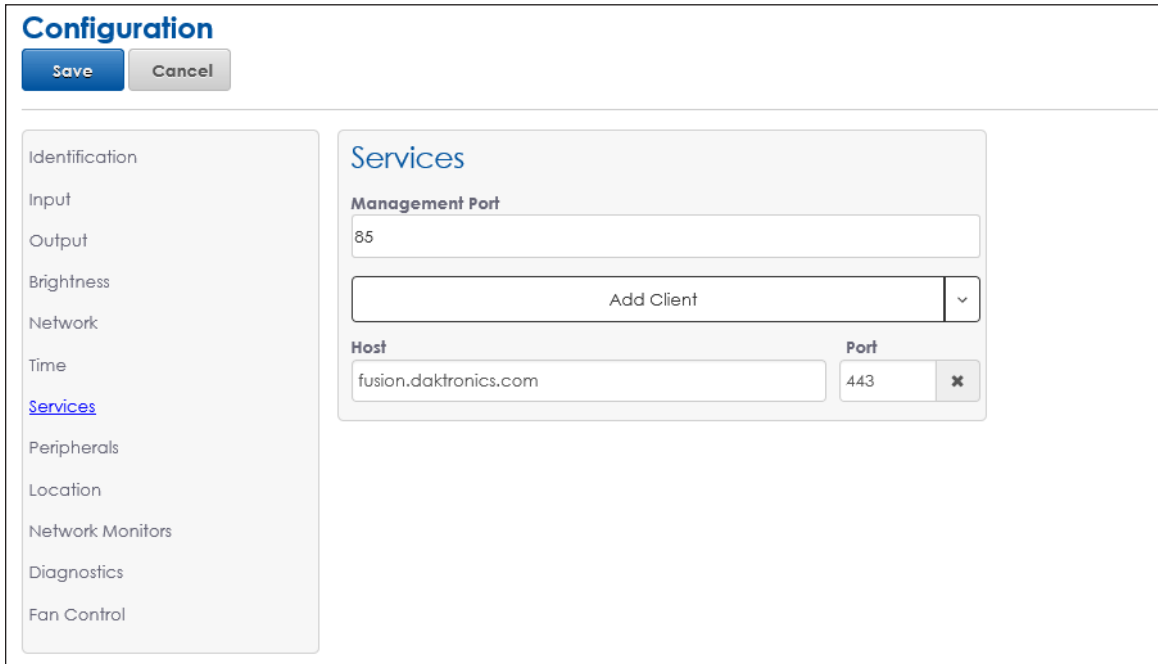

Figure 46: Configuration - Services

The **Management Port** number is appended to the IP address or host name to connect to the user interface. The **Management Port** is usually **85** or **80**.

Choose the desired client program from the drop-down list. Refer to **Figure 47**.

- **Venus - Hosted:** This option is for the Daktronics-hosted (remote, cloud-based) Venus® Control Suite software program. When this is chosen, the **Host** field is **venus.daktronics.com** and the **Port** field is **443** by default. Refer to **Figure 48**.

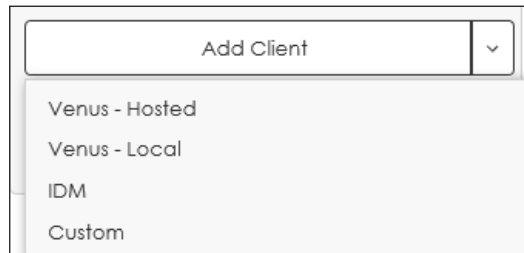

Figure 47: Services - Add Client

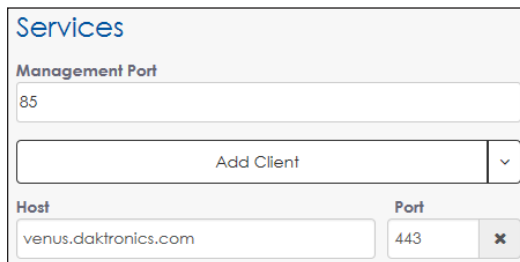

Figure 48: Services - Venus-Hosted

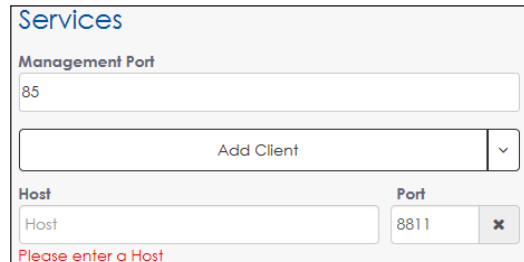

Figure 49: Services - Venus Local

- **Venus - Local:** This option is for the Venus® Control Suite software program that is hosted from a local computer server. When this is chosen, the **Host** field is blank and the **Port** field is **8811** by default. Fill in the correct **Host** information before saving. Refer to **Figure 49**.

- **IDM:** This option is for the Daktronics Intelligent Device Management (IDM) system, an internet-based monitoring and diagnostic system. When this is chosen, the **Host** field is **fusion.daktronics.com** and the **Port** field is **443** by default. Refer to **Figure 50**.

The screenshot shows the 'Services' configuration interface. At the top, there is a 'Management Port' field with the value '85'. Below it is an 'Add Client' dropdown menu. At the bottom, there are two input fields: 'Host' with the value 'fusion.daktronics.com' and 'Port' with the value '443'.

Figure 50: Services - IDM

The screenshot shows the 'Services' configuration interface for the Custom option. The 'Management Port' is '85'. The 'Host' field is empty, and the 'Port' field is '80'. A red error message 'Please enter a Host' is displayed below the Host field.

Figure 51: Services - Custom

- **Custom:** Use this option to configure the processor to communicate with any software program not listed in the drop-down list. When this is chosen, the **Host** field is blank and the **Port** field is **80** by default. Refer to **Figure 51**.

Peripherals

Peripherals configures peripheral devices such as display sensors. Refer to **Figure 52**.

The screenshot shows the 'Configuration' page with a sidebar on the left containing options like Identification, Input, Output, Brightness, Network, Time, Services, **Peripherals**, Location, Network Monitors, Diagnostics, and Fan Control. The main content area is titled 'Peripherals' and features an 'Add Peripheral' dropdown. Below it, a 'Light' device is configured with the following settings: Type: CAN, Address: 1, and Connection: Controller.

Figure 52: Configuration - Peripherals

The processor has a Phoenix connection that may be used for DCIO ports. DCIO ports allow the processor to communicate with up to six external devices.

Choose a peripheral sensor from the **Add Peripheral** drop-down list. Refer to **Figure 53**.

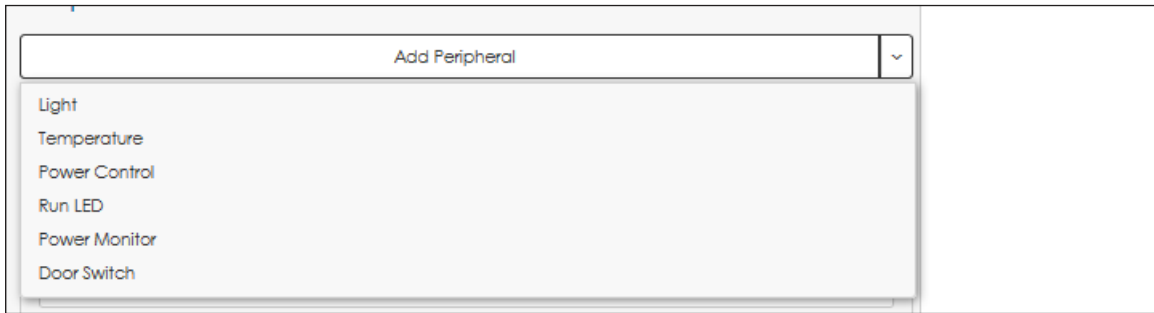

Figure 53: Peripherals - Add Peripheral

If a peripheral device is configured but the VIP is unable to receive responses, a red banner opens at the top of the device configuration section. Refer to **Figure 54**.

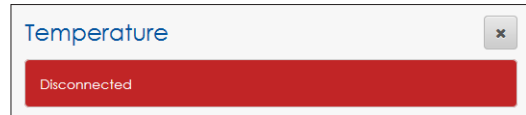

Figure 54: Disconnected Peripheral Device

Light

A light sensor automatically controls display brightness based on ambient light conditions. To configure a light sensor, follow these steps while referring to **Figure 55**.

1. Select the correct type of light sensor assembly from the **Type** drop-down list. The default light sensor is **CAN** (Controller Area Network).

- **CAN** – A controller area network based sensor that returns light intensity readings.
- **CAN Lux** – A controller area network based sensor that returns light intensity readings in LUX units. The default sensor response setting is **Automatic**; change this setting only under the direction of Daktronics technicians.

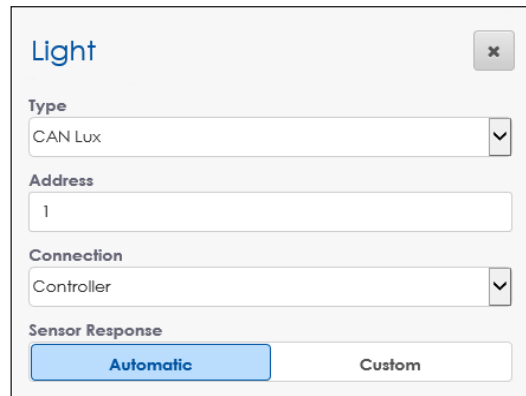

Figure 55: Peripherals - Light Sensor

- **CAN Multi Directional** – A controller area network based sensor that returns light intensity readings or LUX unit light readings from several directions.

2. Enter the sensor's configured address in the **Address** field.

3. Select the connection type from the **Connection** drop-down list.

4. Set the **Sensor Response** to **Automatic** or **Custom**. Refer to **Figure 56**.

- **Automatic** - The standard linear brightness curve that gradually increases the brightness from **0%** to **100%** as the sensor value increases from **0 LUX** to **212 LUX**.
- **Custom** - Set the sensor readings used to determine the display brightness curve. This setting is not usually needed.

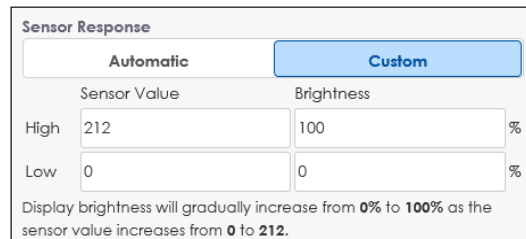

Figure 56: Peripherals - Sensor Response

5. Click **Save** at the top of the screen to save the changes.

Temperature

An external temperature sensor is connected to the controller and used for logging the current temperature at the display location. To configure the temperature sensor, follow these steps while referring to **Figure 57**.

1. Enter the sensor's configured address in the **Address** field.
2. Select the connection type from the **Connection** drop-down list.
3. Adjust the temperature offset if necessary by typing in a value in the **Offset** field or by moving the offset slider. The default offset is **0**.

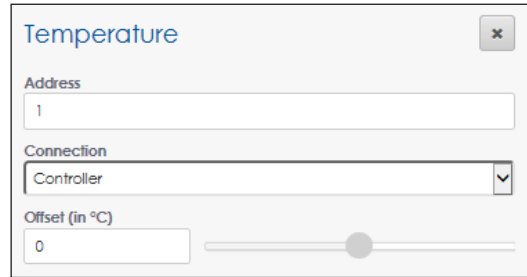

Figure 57: Peripherals - Temperature Sensor

Note: The offset adjusts the external temperature sensor at the display site to compensate for environmental conditions such as a sensor mounted too close to a heat source or in the shade. These conditions will affect the temperature reading by a specified amount (-9 °C to +9 °C).

4. Click **Save** at the top of the screen to save the changes.

Power Control

Many displays include four standard power control relays. To configure these relays, follow these steps while referring to **Figure 58**.

1. Type a descriptive name for the power control relay in the **Relay** field. The example in **Figure 58** shows four relay names typically used in a standard billboard display.
2. Choose the power control option from the drop-down list. This choice determines the reset option(s) available for the power relay under **Troubleshooting**. Refer to **Power Control (p.46)**.

- **Cycle** – sends a command to turn the relay off for 10 seconds and then turns it back on
- **On/Off** – sends an On or Off command. The relay remains in the On or Off state until the user makes a change. Be careful to not turn off relays that may be connected to the processor.
- **Full** – includes both the **Cycle** and **On/Off** options listed below

3. Click **Save** at the top of the screen to save the changes.

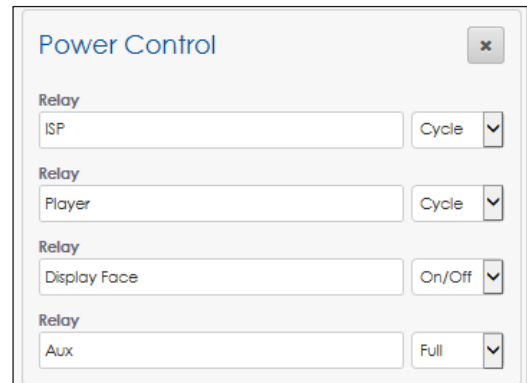

Figure 58: Peripherals - Power Control

Note: Not all displays are shipped with power relay controls.

Run LED

The run LED sensor configures the processor's external "heartbeat" LED indicating the processor is on and operational. To configure the run LED sensor, follow these steps while referring to **Figure 59**.

1. Choose **Automatic** or **Manual**.
 - **Automatic** – the address is automatically detected by the processor. The default address is **4**.
 - **Manual** - the address is set manually.
2. Enter the address in the **Address** field if **Manual** was chosen in **Step 1**.
3. Click **Save** at the top of the screen to save the changes.



The screenshot shows a configuration window titled "Run LED". It has a close button in the top right corner. Below the title is the "Address Configuration" section, which contains two buttons: "Automatic" and "Manual". The "Manual" button is highlighted in blue, indicating it is selected. Below this is an "Address" field with a text input box containing the number "1".

Figure 59: Peripherals - Run LED

Power Monitor

The power monitor sensor detects power loss. If the display is connected to a Daktronics power supply, a loss of power sends an immediate diagnostic notice to IDM indicating a power failure condition has occurred.

To configure the power monitor sensor, follow these steps while referring to **Figure 60**.

1. Choose **Automatic** or **Manual**.
 - **Automatic** – the address is automatically detected by the processor. The default address is **3**.
 - **Manual** - the address is set manually.
2. Enter the address in the **Address** field if **Manual** was chosen in Step 1.
3. Click **Save** at the top of the screen to save the changes.

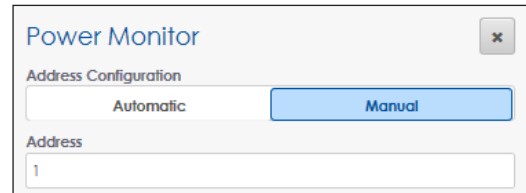

The screenshot shows a configuration window titled "Power Monitor". It has a close button in the top right corner. Below the title is the "Address Configuration" section, which contains two buttons: "Automatic" and "Manual". The "Manual" button is highlighted in blue, indicating it is selected. Below this is an "Address" field with a text input box containing the number "1".

Figure 60: Peripherals - Power Monitor

Door Switch

The door switch sensor detects door openings. By default, an open door disables video input and switches to the **Default Content** mode. To configure the door sensor, follow these steps while referring to **Figure 61**.

1. Choose **Automatic** or **Manual**.
 - **Automatic** – the address is automatically detected by the processor. The default address is **2**.
 - **Manual** - the address is set manually.
2. Enter the address in the **Address** field if **Manual** was chosen in Step 1.
3. Click **Save** at the top of the screen to save the changes.

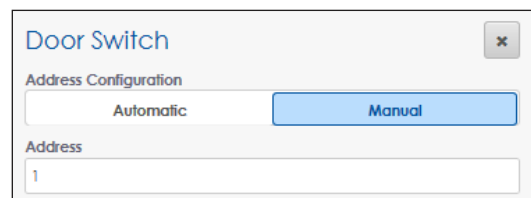

The screenshot shows a configuration window titled "Door Switch". It has a close button in the top right corner. Below the title is the "Address Configuration" section, which contains two buttons: "Automatic" and "Manual". The "Manual" button is highlighted in blue, indicating it is selected. Below this is an "Address" field with a text input box containing the number "1".

Figure 61: Peripherals - Door Switch

Location

Location sets the display's location. Configure the location manually to calculate the appropriate dimming level. Refer to **Figure 62**.

Configuration

Save Cancel

Identification
Input
Output
Brightness
Network
Time
Services
Peripherals
Location
Network Monitors
Diagnostics
Fan Control

Location

Continent
North America

Country
USA

State/Province
South Dakota

City
Brookings

Latitude			
Degrees	Minutes	Seconds	Direction
44	18	0	North

Longitude			
Degrees	Minutes	Seconds	Direction
96	47	24	West

Figure 62: Configuration - Location

Configure the following location parameters:

- **Continent:** Select the continent where the display is installed. If the appropriate continent is not shown, select **Other**.
- **Country:** Select the country where the display is installed.
- **State/Province:** Select the state or province where the display is installed if **North America** is selected as the **Continent**.
- **City:** Select the city where the display is installed.
- **Latitude/Longitude:** Select the display's latitude and longitude coordinates. These values either populate automatically based on the **Continent, Country, State/Province**, and **City** information or they can be entered manually.

Network Monitors

Network Monitors configures the monitoring system for the network. Monitors are used in conjunction with power control relays and attempt a recovery if a device becomes unresponsive on the network. The power control relays must be configured under the **Peripherals** menu before setting up the network monitors. Refer to **Power Control (p.30)**.

Network monitors ping the player to determine why the display is not working, possibly eliminating the need for a service call. Refer to **Figure 63**.

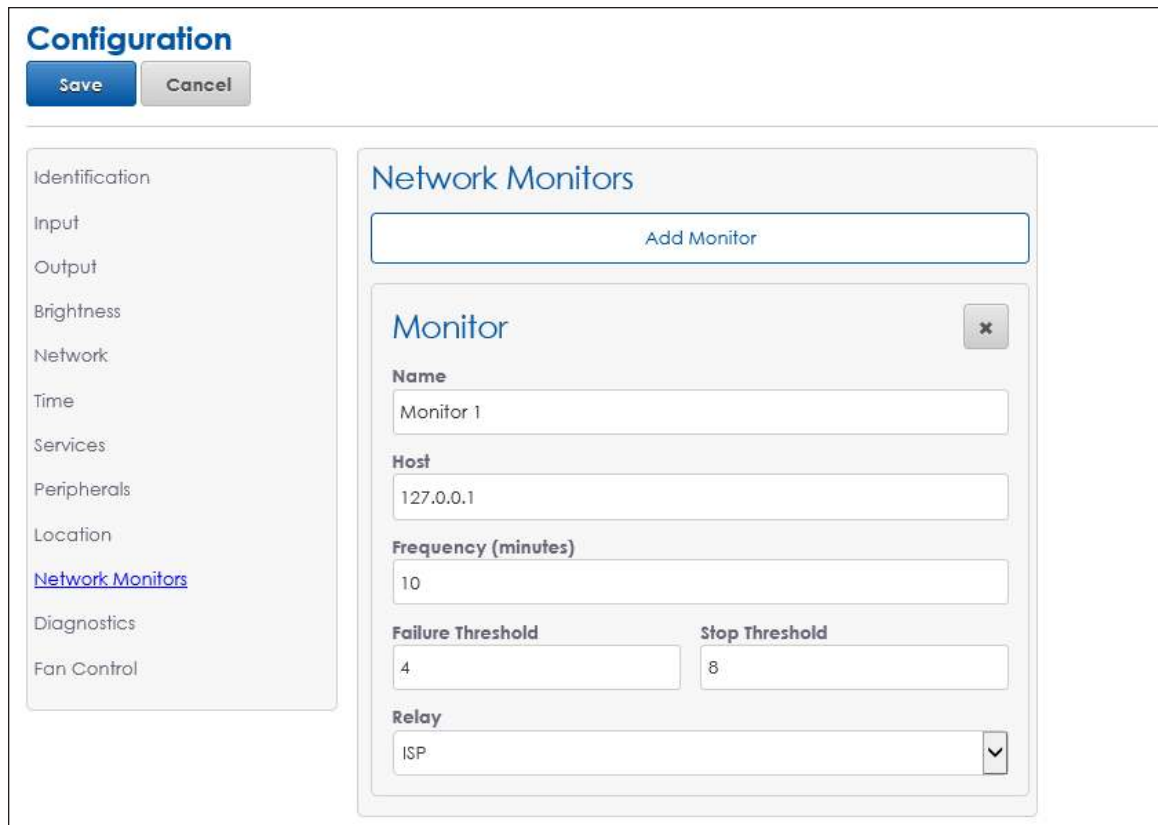

The screenshot displays the 'Configuration' window for 'Network Monitors'. On the left is a sidebar with a list of configuration categories: Identification, Input, Output, Brightness, Network, Time, Services, Peripherals, Location, Network Monitors (highlighted in blue), Diagnostics, and Fan Control. The main area is titled 'Network Monitors' and features an 'Add Monitor' button. Below this is a 'Monitor' configuration panel with a close button (x). The fields are: Name (Monitor 1), Host (127.0.0.1), Frequency (minutes) (10), Failure Threshold (4), Stop Threshold (8), and Relay (ISP).

Figure 63: Configuration - Network Monitors

To configure network monitors, follow these steps:

1. Click **Add Monitor** to open the **Monitor** window.
2. Type a descriptive name in the **Name** field.
3. Type the host address in the **Host** field.
4. Enter how often the monitor will check the network in minutes (1 to 60) in the **Frequency** field.
5. Type the number of times the system will receive a failure message before an action is taken in the **Failure Threshold** field.
6. Type the number of times the system will receive a failure message before the action is stopped in the **Stop Threshold** field.
7. Choose the desired power control relay from the **Relay** drop-down list.
8. Click **Save** at the top of the screen to save the changes.

Diagnostics

Diagnostics updates the diagnostic files used by the processor to return data to IDM. The current version for the diagnostic files is listed under **Display Firmware Version**. Refer to **Figure 64**.

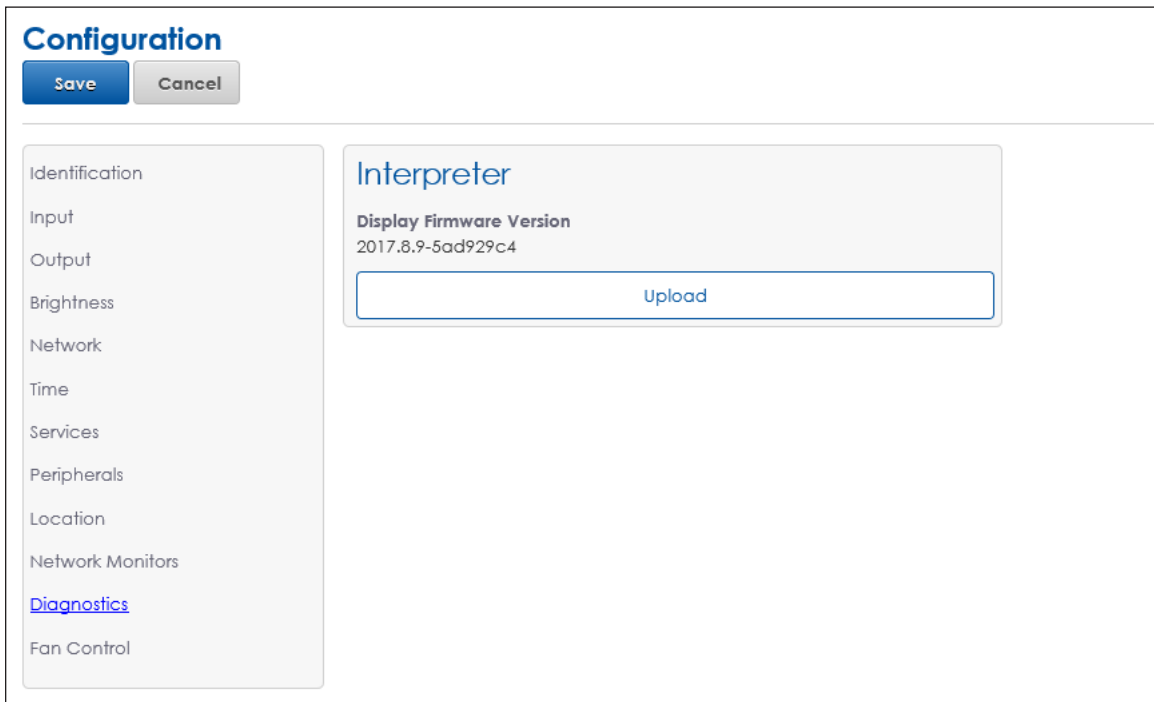

Figure 64: Configuration - Diagnostics

To update the display firmware, follow these steps.

1. Click **Upload** under the **Interpreter** section as shown in **Figure 64**. This triggers an **Open** dialog box.
2. Select the desired firmware package to upload (.deb or .hex file type).
3. Click **Open** to complete the upload and return to **Diagnostics**.
4. Click **Save** at the top of the screen to save the changes. The new file transfers to the display and the update is performed.

Note: This action does not update the VIP processor firmware. To update the processor firmware, click the **Firmware** tile in the **Dashboard** and then click **Update**. Refer to **Dashboard Tiles (p.7)**.

Fan Control

Fan Control provides three different methods for controlling the internal ventilation of the display cabinet. The **Fan Control** settings determine when the display fans will turn on and off. Refer to **Figure 65**.

The screenshot shows the 'Configuration' window for 'Fan Control'. It features a sidebar menu on the left with the following items: Identification, Input, Output, Brightness, Network, Time, Services, Peripherals, Location, Network Monitors, Diagnostics, and **Fan Control** (highlighted). The main content area contains three control panels:

- PLR Fan Control:** High (°C) is 40, Low (°C) is 25.
- Brightness Fan Control:** The 'Active' toggle is selected. High (%) is 85, Low (%) is 10.
- Cabinet Fan Control:** The 'Active' toggle is selected. Offset (°C) is 5, High (°C) is 30, and Low (°C) is 22.

Figure 65: Configuration - Fan Control

PLR Fan Control

This sets the high and low temperatures that trigger the display fans. The fans will turn on once 10% or more of the modules exceed the **High** value. The fans continue to run until all modules reach the **Low** value.

Brightness Fan Control

If **Active**, the **Brightness Fan Control** sets high and low brightness percentages that trigger the display fans. The fans will turn on once the display brightness percentage reaches the **High** value. The fans continue to run until the brightness percentage reaches the **Low** value. The default state is **Inactive**.

Cabinet Fan Control

If **Active**, the **Cabinet Fan Control** sets the high and low temperatures that trigger the display fans. The fans will turn on once the PLR temperature sensor reaches the **High** value. The fans continue to run until the PLR temperature sensor reaches the **Low** value. This control is used most often with the Street Furniture product line.

Note: The cabinet fan control **Offset** adjusts the PLR temperature sensor reading up or down (-30 °C to +30 °C). As shown in **Figure 65**, if the PLR sensor reads 30 °C with an offset of +5 °C, the effective reading is 35 °C. In this case, the fans will not be triggered since this is below the configured high point of 40 °C.

5 Monitor

Click **Monitor**  to open a window showing a video feed of the display input or output content. This video plays on a canvas that represents the display size. Refer to **Figure 66**.

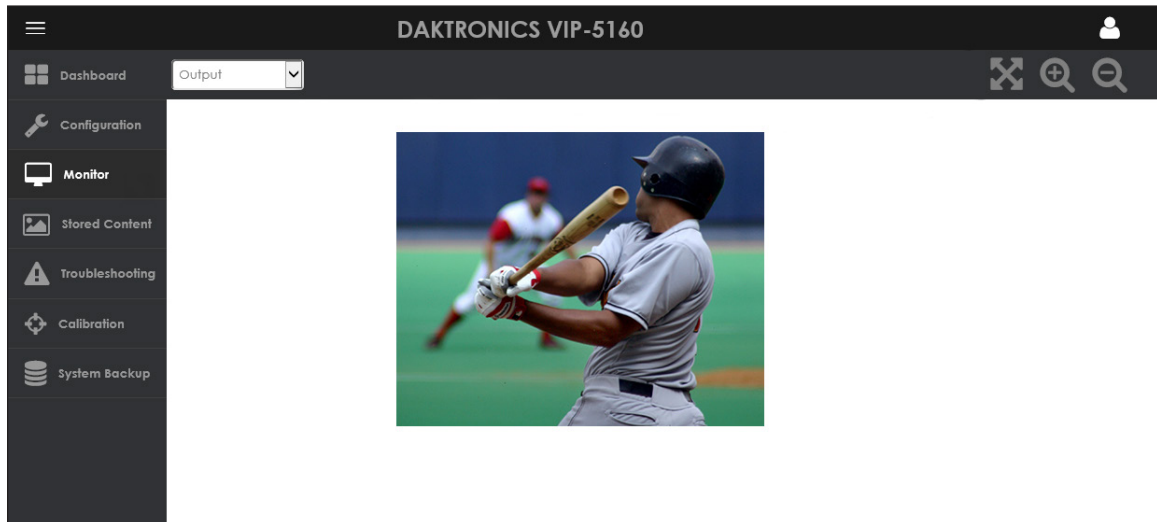



Figure 66: Monitor

Click the arrow and magnifying glass icons  at the top of the video feed to make the monitor window larger, smaller, or back to scale.

6 Stored Content

Click **Stored Content**  to open a library for stored image files. Stored image files are used in a display mode that shows locally stored content when the primary video source is unavailable or when a specific action occurs (i.e. a door switch sensor is triggered when a cabinet door opens). Image files are easily added or deleted from this list. Refer to **Figure 67**.

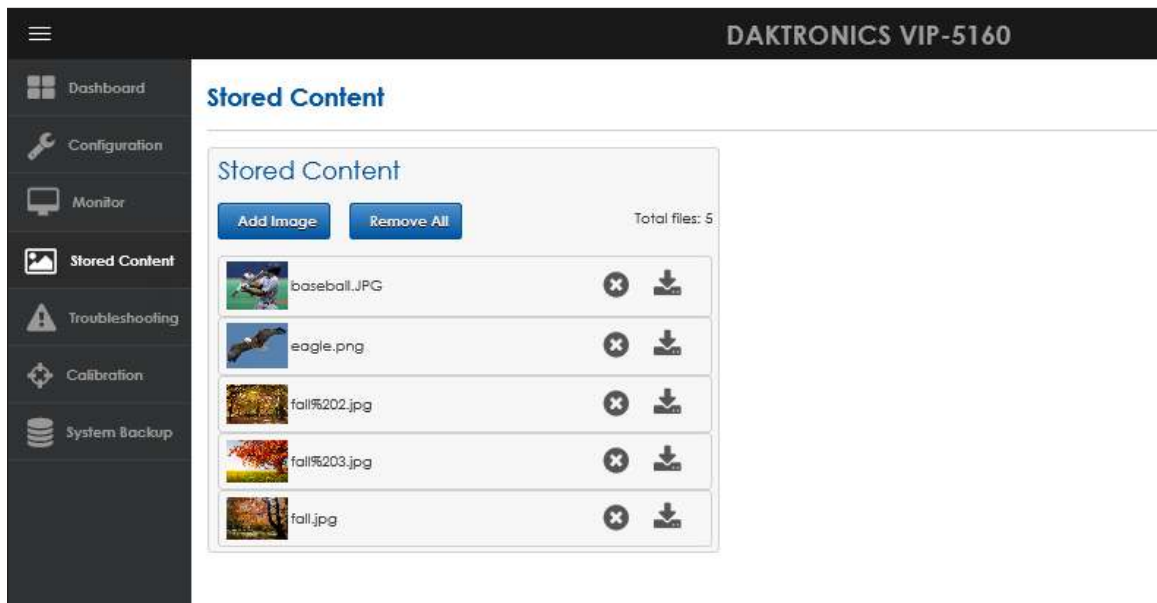



Figure 67: Stored Content

Managing Stored Content Files

To manage the stored content files, follow these steps while referring to **Figure 67**.

1. Click **Add Image**. This triggers an **Open** dialog box.
2. Select the desired image(s) to upload. The image(s) are added to the list in the order they are uploaded.
3. Click the delete icon  to remove any uploaded image.

Note: Use caution when deleting any stored content files. The file is deleted as soon as the user clicks the delete icon next to the file name.

4. Click the download icon  to download a stored image from the processor.
5. Click **Remove All** at the top of the screen to remove all stored content files.

Note: Use caution when removing all stored content files. The files are deleted as soon as the user clicks the **Remove All** button.

Supported image types are JPEG, PNG, and 24- and 32-bit. Multiple files can be added at the same time. The number of stored images is limited only by the storage space available on the processor. The available storage space is shown on the dashboard **Storage** file, refer to **Dashboard Tiles (p.7)**.

Images should be added in the order the user wants them to appear on the display. The order of images can be verified by the list of thumbnail images. Refer to **Figure 67**.

Note: Stored content plays only when **Stored Content** is selected from the **Display Mode** drop-down list under **Configuration > Input > Display Mode**. Each image is displayed for the length of time set under **Minimum Hold Time**. Refer to **Stored Content (p.15)**.

7 Troubleshooting

Click **Troubleshooting**  to open a troubleshooting window with a number of tests and options to solve possible problems encountered with the processor. Refer to **Figure 68**.

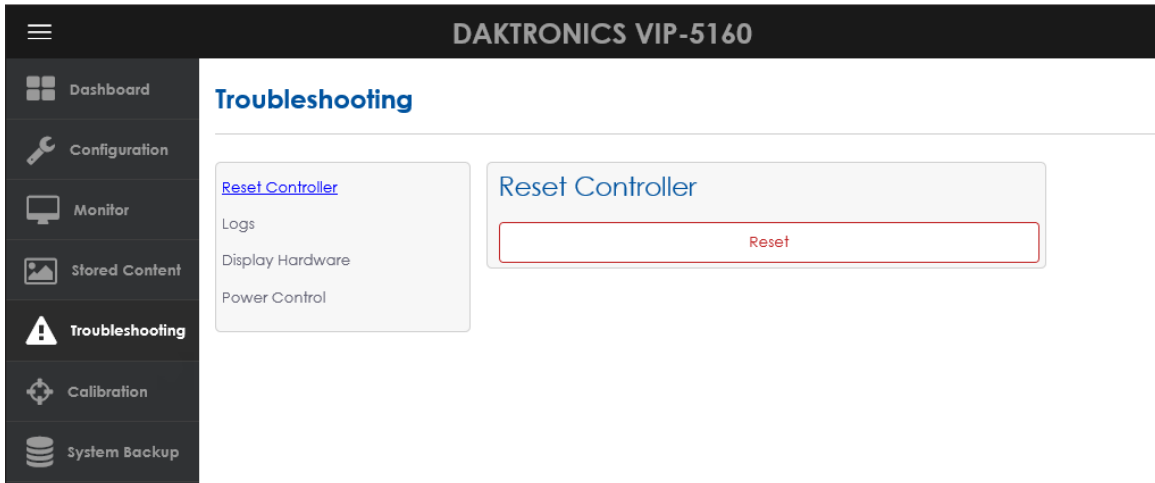

Figure 68: Troubleshooting

Reset Controller

This action restarts the controller remotely and interrupts the current display operation.

Click the red **Reset** button to restart the controller. Refer to **Figure 68**.

A prompt opens to confirm this action since this causes the display to be blank temporarily. Refer to **Figure 69**.

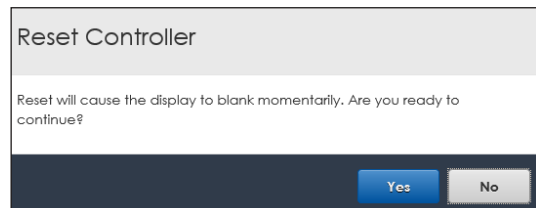

Figure 69: Reset Controller Prompt

Logs

Click **Logs** to export and save the controller log information or view a calibration log.

Save Logs

Click **Save** to export the log information. Refer to **Figure 70**.

A dialog box opens to either open the log file or save it to a default download directory.

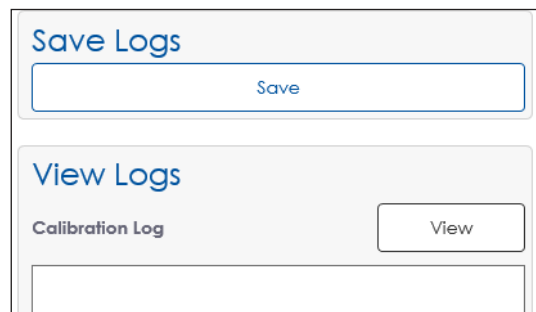

Figure 70: Logs

Note: Daktronics Technical Support may ask to review these exported log files when troubleshooting.

View Logs

Click **View** for log information about auto blending color calibration. This log shows the different color spaces retrieved from the modules and what was applied during the operation. Refer to **Auto Blending (p.50)**.

Display Hardware

Display Hardware Tests verifies all wiring connections are made properly and the hardware components are working correctly. Use these tests along with visual inspection of the display; before using **Display Hardware Tests**, ensure that the display is visible to the user.

During the tests, the processor sends modifiers to the ProLink Router (PLR) systems every five seconds, triggering the display modules to turn red or green. Green modules indicate a pass status and red modules indicate a fail status. Any modules with connection issues will turn red. Refer to **Figure 71**.

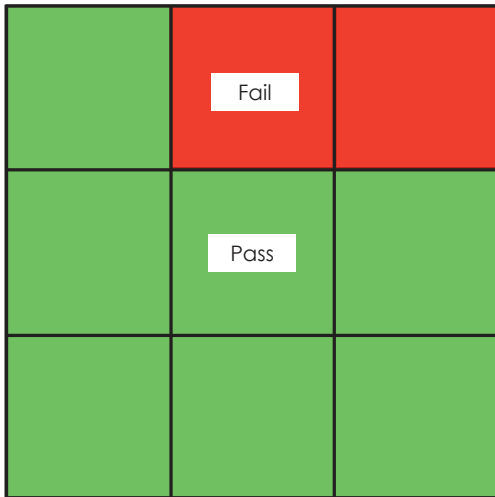

Figure 71: Module Test Status

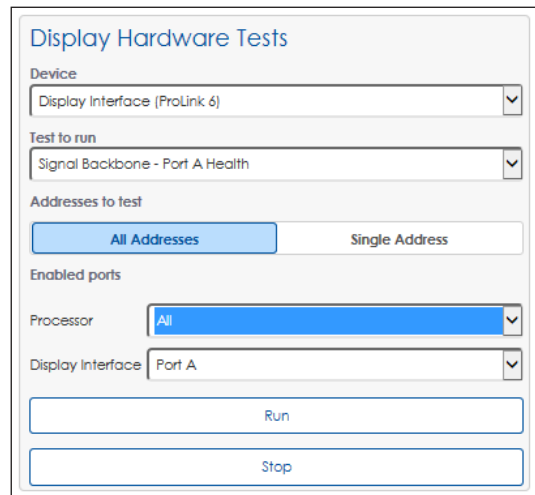

Figure 72: Display Hardware Tests

After choosing the test parameters, click **Run** to start the test. Once the test is complete, click **Stop** to stop the test. Refer to **Figure 72**. After either starting or stopping the test, a **Successfully updated test patterns** message opens in a green banner across the top of the screen.

Note: For complete test results, run each test a few times making corrections in between tests.

Device

Select the desired device type from the **Device** drop-down list. Refer to **Figure 73**.

- **Display Interface (ProLink 6)** tests the display's ProLink 6 PLR signal connections and firmware versions.
- **Module (ProLink 5)** tests the modules' ProLink 5 connections and firmware versions.

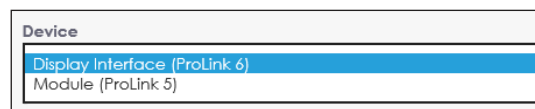

Figure 73: Device Drop-down List

Test to Run

Select the desired hardware test from the drop-down list as shown in **Figure 74**.

The available tests for the **Display Interface (ProLink 6)** device are described below.

- **Signal Backbone - Port A Health** - This tests the ProLink 6 connections via fiber Port A on the PLRs. If the PLR Port A fiber is disconnected, the modules connected to that PLR turn red. Refer to **Figure 75**. If the PLR has proper connection and communication via Port A, the modules connected to that PLR turn green.
- **Signal Backbone - Port B Health** - This tests the ProLink 6 connections via fiber Port B on the PLRs. If the PLR Port B fiber is disconnected, the modules connected to that PLR turn red. Refer to **Figure 75**. If the PLR has proper connection and communication via Port B, the modules connected to that PLR turn green.
- **Output to Module - Port A Health** - This tests the SATA Port A on the PLR. If the SATA Port A is connected to the modules properly, all the modules turn green. If SATA Port A is not connected to the modules correctly, all the modules turn red. Refer to **Figure 75**.
- **Output to Module - Port B Health** - This tests the SATA Port B on the PLR. If the SATA Port B is connected to the modules properly, all the modules turn green. If SATA Port B is not connected to the modules correctly, all the modules turn red. Refer to **Figure 75**.

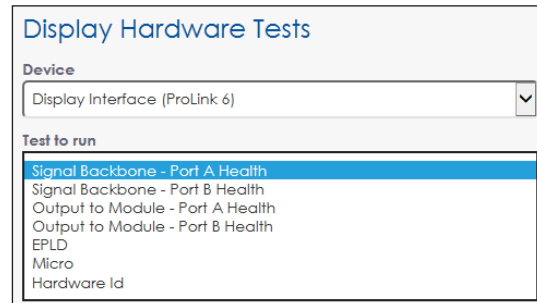

Figure 74: Display Interface (ProLink 6) Tests

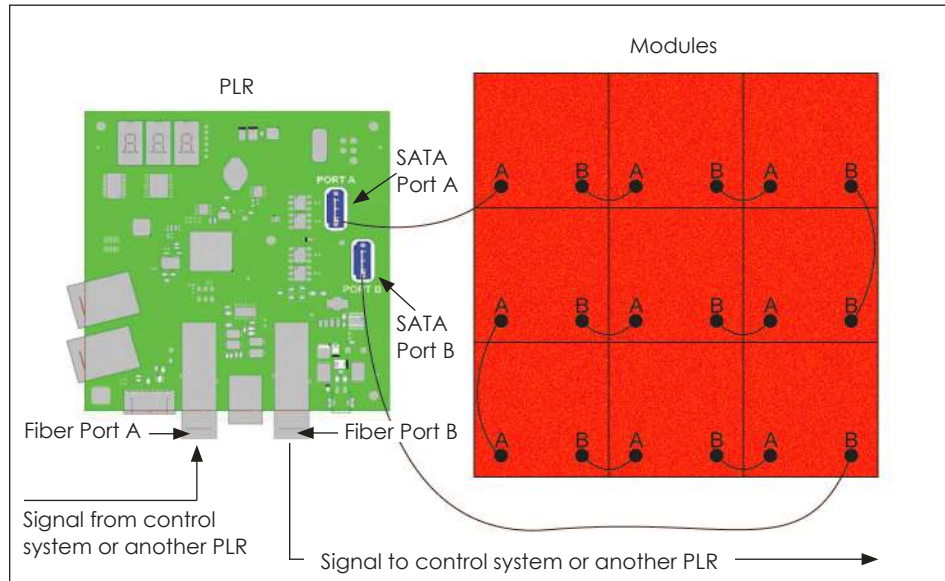

Figure 75: ProLink 6 Failure from Fiber Ports or SATA Ports

- **EPLD** - This tests the EPLD firmware. If all EPLD firmware is the same, all the modules turn green. If there are modules with different firmware, all the modules connected to those PLRs turn red.

- **Micro** - This tests the Micro firmware. If all Micro firmware is the same, all the modules turn green. If there are modules with different firmware, all the modules connected to those PLRs turn red.
- **Hardware Id** - This tests the hardware ID versions. If all the hardware ID versions are the same, all the modules turn green. If there are modules with different hardware ID versions, all the modules connected to those PLRs turn red.

The available tests for the **Module (ProLink 5)** device are shown in **Figure 76** and described below.

- **Module - Port A Health** - This tests the ProLink 5 connections via SATA Port A on the modules. If the SATA cable coming from Port A on a module is disconnected, the modules that do not have a connection to Port A turn red. If the module has proper connection and communication via Port A, the modules turn green. Refer to **Figure 77**.

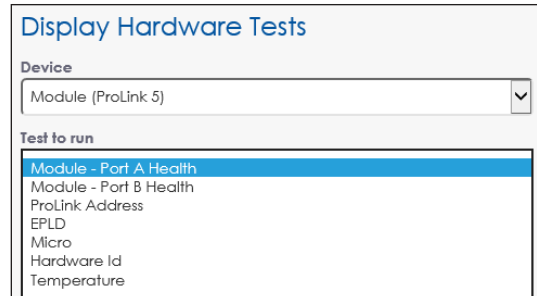

Figure 76: Module (ProLink Controller) Tests

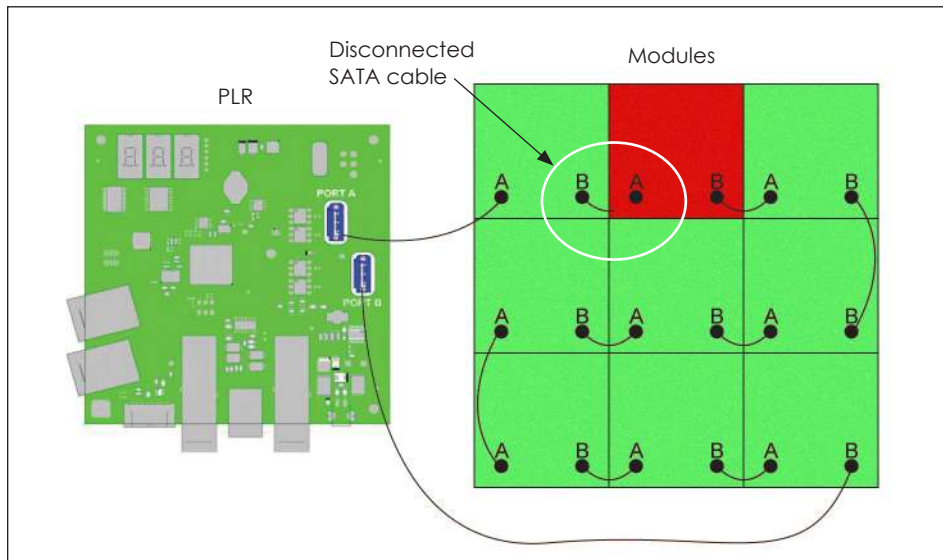

Figure 77: ProLink 5 Failure from Port A

- **Module - Port B Health** - This tests the ProLink 5 connections via SATA Port B on the modules. If the SATA cable coming from Port B on a module is disconnected, the modules that do not have a connection to Port B turn red. If the module has proper connection and communication via Port B, the modules turn green. Refer to **Figure 78**.

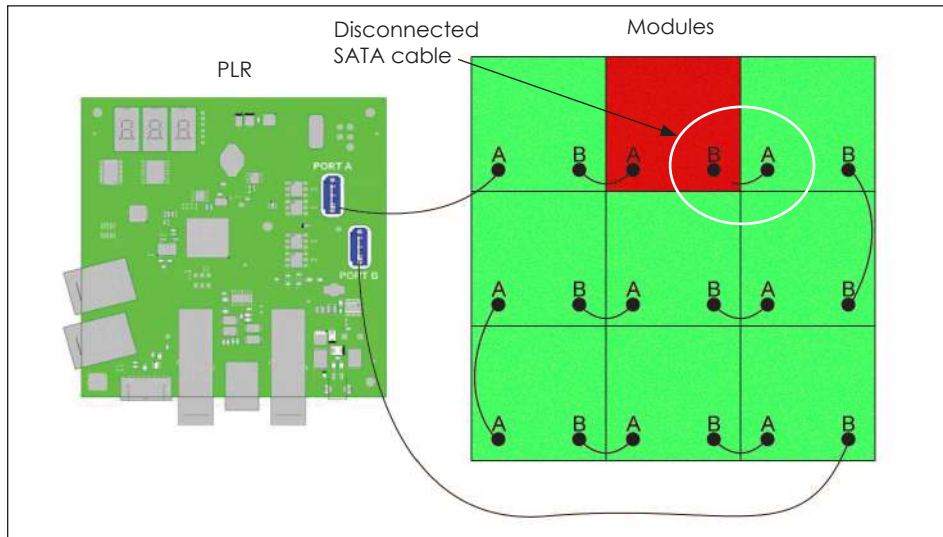

Figure 78: ProLink 5 Failure from Port B

- **ProLink Address** - This tests the display wiring. The modules show their unique, dynamically-assigned ProLink address. If any address is repeated, there is a wiring problem. The first module off the ProLink 6 Port A path has the address number **0** and this number increases by one for each module. Follow the wiring layout in the translation table to verify the address that each module should display.
- **EPLD** - This tests the EPLD firmware. If all EPLD firmware is the same, all the modules turn green. If there are modules with different firmware, all the modules connected to those PLRs turn red.
- **Micro** - This tests the Micro firmware. If all Micro firmware is the same, all the modules turn green. If there are modules with different firmware, all the modules connected to those PLRs turn red.
- **Hardware Id** - This tests the hardware ID versions. If all the hardware ID versions are the same, all the modules turn green. If there are modules with different hardware ID versions, all the modules connected to those PLRs turn red.
- **Temperature** - This indicates if a module is too hot or cold. If a module is too hot or cold, it turns red. If the module temperature is within the acceptable range, it turns green.

Addresses to Test

Choose **All Addresses** to test all connections. To target the test to a specific device, select **Single Address** and then enter that device's address.

Enabled Ports

Choose which output port to test. The **Processor** port broadcasts to the display from the processor's ProLink6 output (e.g. VIP, DI, or VP). The **Display Interface** is the PLR node that is active. (e.g. Port A = Primary PLR, Port B = Secondary PLR). Refer to **Figure 79**.

Enabling a specific port allows technicians to test the primary and secondary processor links without unplugging fiber-optic or SATA cables.

Enabled ports	
Processor	All
	Port A
	Port B
Display Interface	All
	Port A
	Port B

Figure 79: Enabled Ports

Note: Do not use this feature unless instructed to do so by Daktronics technicians.

If **Port A** (ProLink 6) is selected from the **Processor** drop-down list, the processor Port B (ProLink 6) is disabled, forcing the display to run only on its Port A link from the processor. Refer to **Figure 80**.

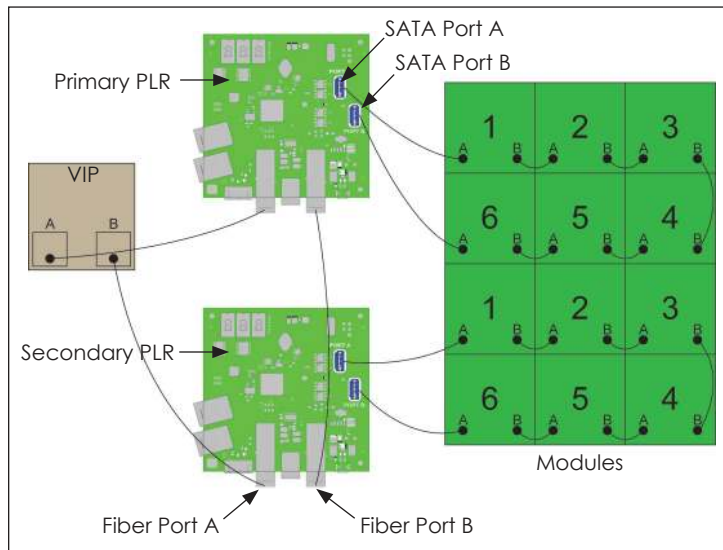

Figure 80: Primary and Secondary Processor Connections

In a system using a single PLR to run a group of modules, selecting **Port A** from the **Display Interface** drop-down list has no effect on the display section. Selecting **Port B** blanks the display because there is no secondary PLR. Refer to **Figure 81**.

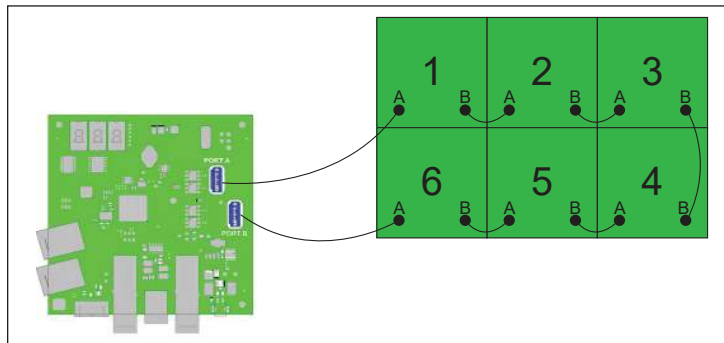

Figure 81: Setup Using One PLR

In a system using two PLRs to run a display section, one PLR output is the primary link, and the other PLR is the secondary link. In this setup, selecting **Port A** from the **Display Interface** drop-down list disables the secondary PLR and shows problems detected by the primary PLR. Selecting **Port B** from the drop-down list disables the primary PLR and shows problems detected by the secondary PLR. Refer to **Figure 82**.

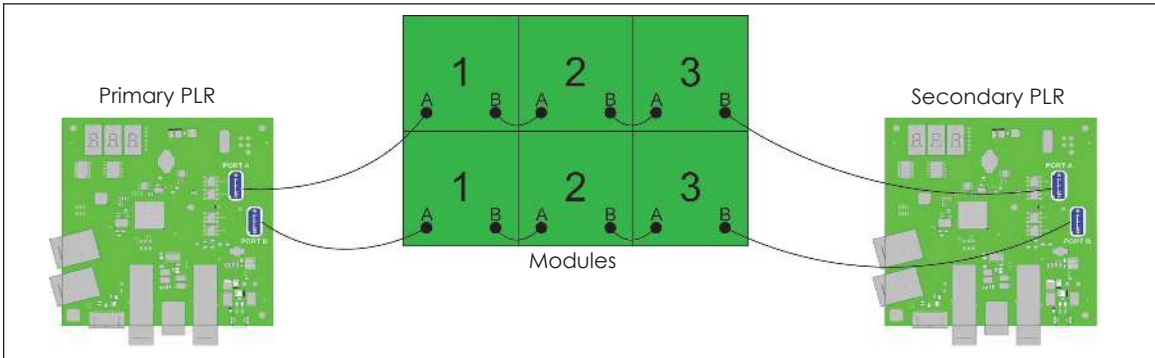

Figure 82: Setup Using Two PLRs

In a system using three PLRs to run display sections, one PLR output is the primary link, and the other PLR ports are secondary links. For the setup shown in **Figure 83**, PLR B is the primary link and PLR A and PLR C are the secondary links. PLR B is determined to be the primary link because the starting points of each module group connect to the SATA ports of PLR B.

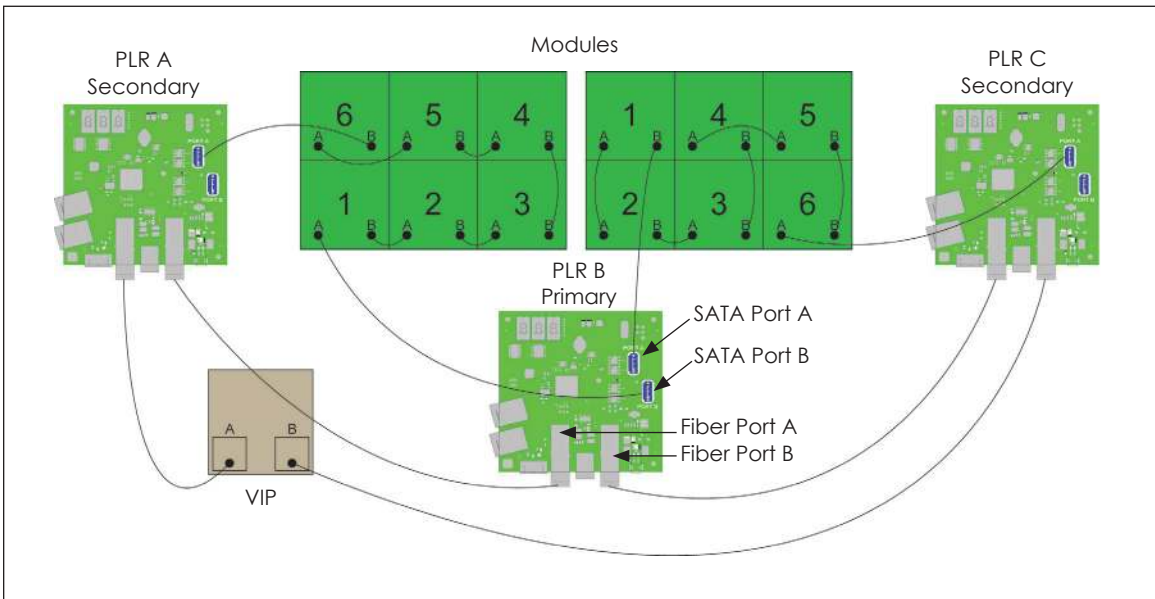

Figure 83: Setup Using Three PLRs

Power Control

Serial Loopback Test

This test verifies the serial cable functionality of a configured power relay control device.

After clicking **Run Loopback Test**, the user is prompted to connect the transmit and receive pins on the serial cable. Refer to **Figure 84**. Click **Yes** to start the test or **No** to exit.

After the loopback test is completed, a success or failure banner opens at the top of the page.

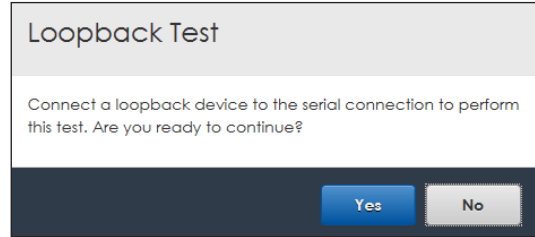

Figure 84: Serial Loopback Test Prompt

ISP

The **ISP** relay is a standard power control relay. Refer to **Power Control (p.30)** for information about configuring relays. Click **Cycle** to restart the **ISP** relay (the power is turned off and then back on). Refer to **Figure 85**. After the relay test is completed, a success or failure banner opens at the top of the page.

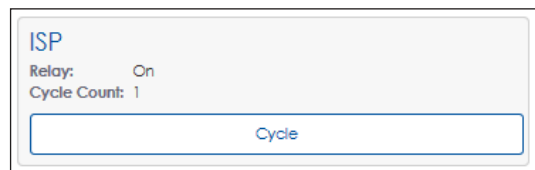

Figure 85: ISP Relay Control

Player

The **Player** relay is a standard power control relay. Refer to **Power Control (p.30)** for information about configuring relays. Click **Cycle** to restart the **Player** relay (the power is turned off and then back on). Refer to **Figure 86**. After the relay test is completed, a success or failure banner opens at the top of the page.

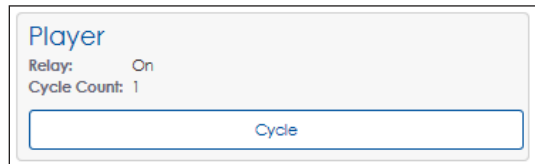

Figure 86: Player Relay Control

Display Face

The **Display Face** relay is a standard power control relay. Refer to **Power Control (p.30)** for information about configuring relays. Click **On/Off** to restart the **Display Face** relay (the power is turned either on or off). Refer to **Figure 87**. After the relay test is completed, a success or failure banner opens at the top of the page.

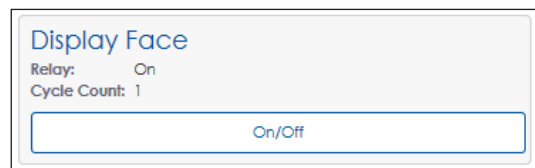

Figure 87: Display Face Relay Control

Aux

The **Aux** relay is a standard power control relay. Refer to **Power Control (p.30)** for information about configuring relays. In the example shown in **Figure 88**, there are two options for starting testing this relay. Click **On/Off** to restart the **Aux** relay (the power is turned either on or off) or click **Cycle** to restart the **Aux** relay (the power is turned off and then back on). After the relay test is completed, a success or failure banner opens at the top of the page.

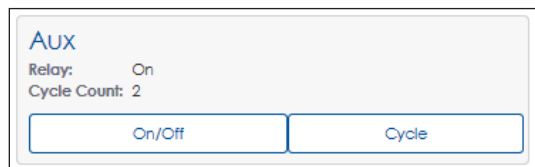

Figure 88: Aux Relay Control

Power Relay Control

Click the red **Reset Power Control** button to perform a soft restart of the power relay control device. Refer to **Figure 89**.

After clicking **Reset Power Control**, a prompt opens to confirm the action since this clears all cycle counts and returns relays to the default state.

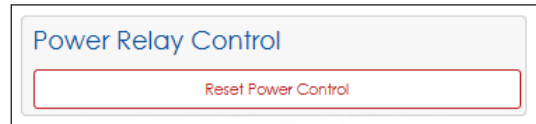



Figure 89: *Reset Power Control*

8 Calibration

Click **Calibration**  to open a window with options for adjusting the display output. Refer to **Figure 90**.

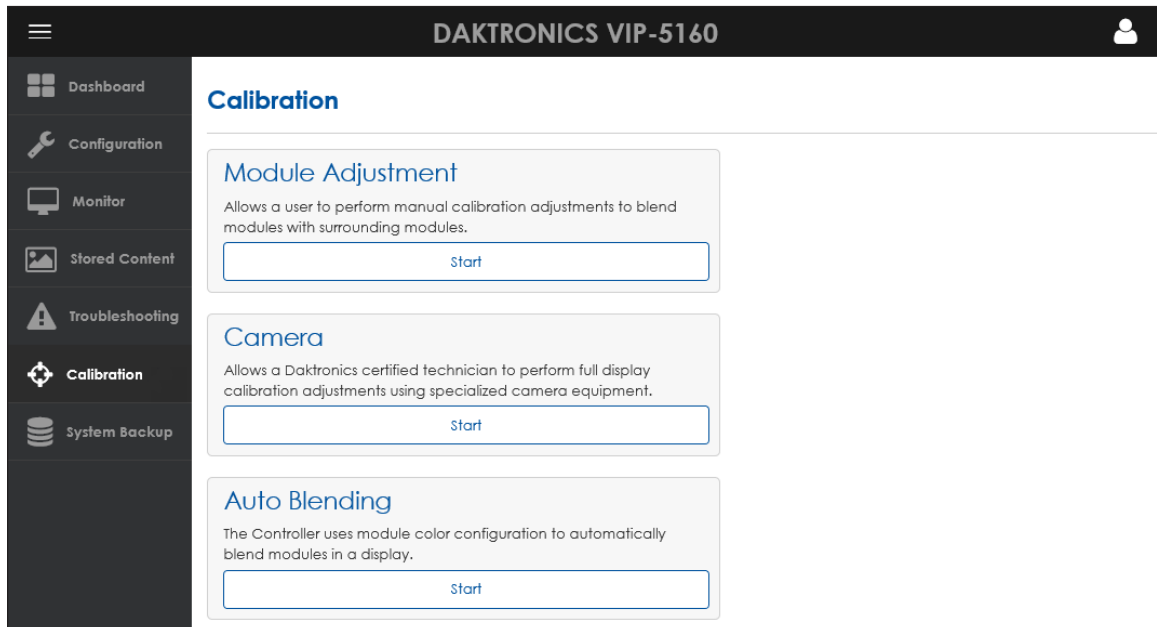

Figure 90: Calibration

Module Adjustment

Module Adjustment manually adjusts individual modules or tiles to improve the uniform intensity of the entire display.

Note: This action interrupts the active content on the display.

To manually adjust the module(s), follow these steps:

1. Click **Start**. A **Session Options** window opens. Refer to **Figure 91**.

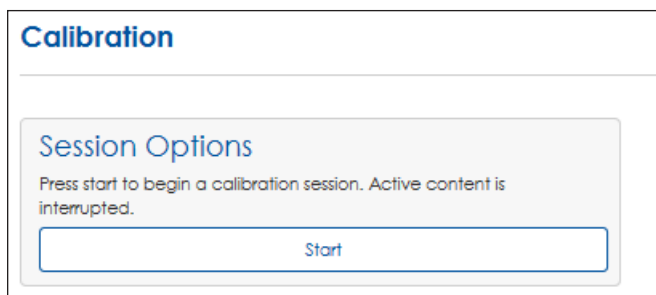

Figure 91: Calibration Session Options

Note: If the display is configured for more than one face, select the desired display face from the drop-down list. If the display has only one face, this option is not shown.

- Click **Start** again to open the **Module Adjust** tool. A graphic representation of the display modules opens with adjustment tools along the right side. Refer to **Figure 92**.

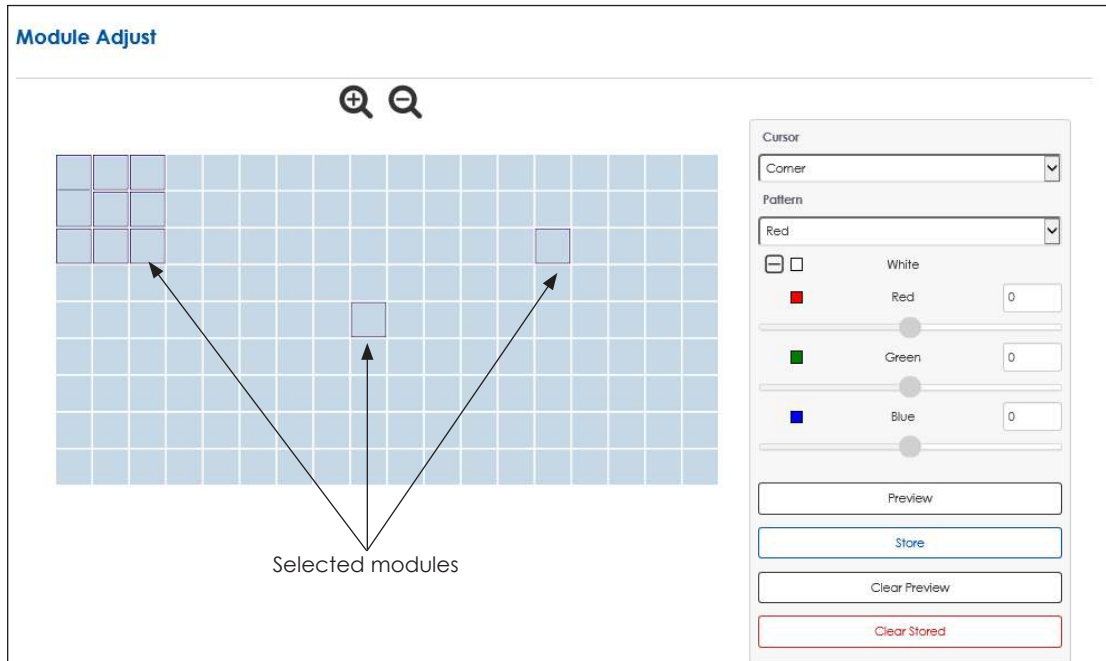

Figure 92: Module Adjustment

- Select individual modules or groups of modules for adjustment by highlighting them with the cursor. Select adjacent modules by clicking and dragging the cursor; select adjacent and non-adjacent modules by using the cursor and **Ctrl** key.
- Choose how the modules will be identified during the adjustment process with the **Cursor** drop-down list. Refer to **Figure 93**.



Figure 93: Cursor Options

- **Outline** - Shows the chosen color pattern on all modules with the selected module(s) outlined in black
 - **Highlight** - Shows the chosen color pattern only on the selected module(s)
 - **Corner** - Shows the chosen color pattern on all modules with the selected module(s) having a black chevron at each corner
- Choose a display output color from the **Pattern** drop-down list to see the module's current color calibration and evaluate the need for manual module adjustment. Refer to **Figure 94**.

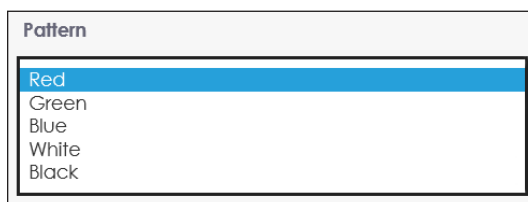

Figure 94: Output Color Patterns

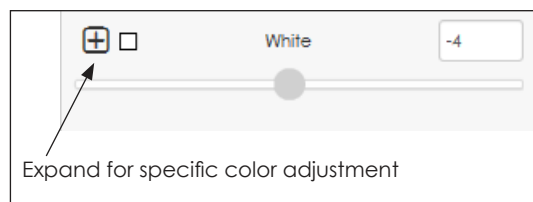



Figure 95: White Adjustment

- Adjust the selected module(s) using the **White** slider. This action uniformly adjust the red, green and blue values. Refer to **Figure 95**.

7. Click the expand icon  as shown in **Figure 95** to adjust the specific red, green, or blue values. Adjust the values for any of these colors with the sliders or by entering values in the text boxes. Refer to **Figure 96**.
8. Click one or more of the following options after adjusting the modules:
 - a. Click **Preview** to see how the adjusted modules look on the display.
 - b. Click **Store** to save the newly changed calibration values.
 - c. Click **Clear Preview** to clear the recently made changes (all changes made since the last **Store**).
 - d. Click **Clear Stored** to delete the stored manual module calibration. If the display is camera calibrated, this will become the default, otherwise the settings will revert to the factory default.

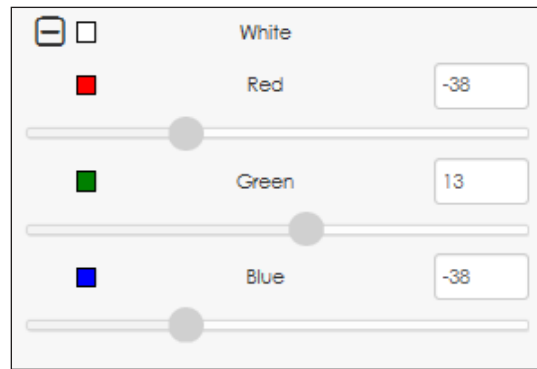

Figure 96: Color Adjustment

Note: After clicking **Clear Stored**, a confirmation prompt opens since this action removes the stored manual calibration from the entire display. Press **Yes** to clear the manual calibration settings, or **No** to exit. Refer to **Figure 97**.

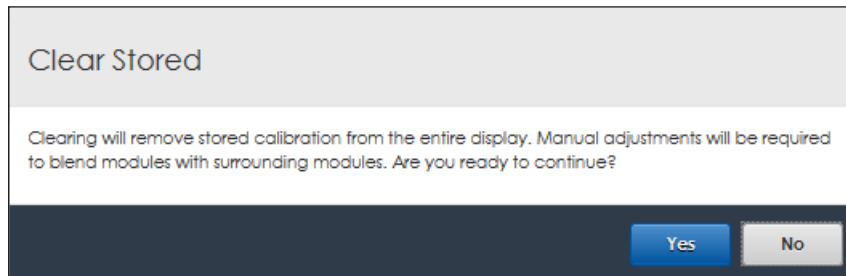

Figure 97: Clear Stored Calibration Settings

Camera

Camera calibration adjusts the intensity level of each pixel in a Daktronics LED video display as needed to improve the uniform intensity of the entire display.

Note: Camera calibration should only be performed by Daktronics technicians.

Auto Blending

Auto Blending automatically adjusts individual modules to improve the uniform intensity of the entire display.

Note: This action interrupts the active content on the display.

To automatically adjust the modules, follow these steps:

1. Click **Start**. A **Session Options** window opens. Refer to **Figure 98**.

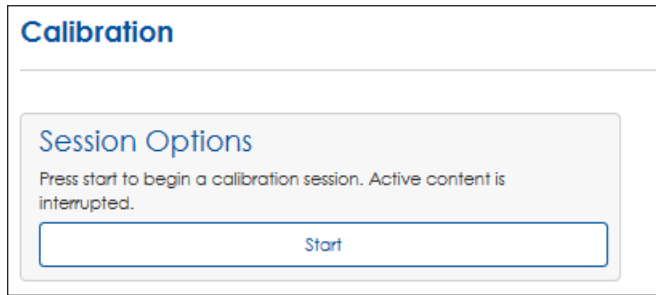

Figure 98: Calibration Session Options

2. Click **Start** again to open the **Autoblend Calibration** tool.
3. Choose a display output color from the **Pattern** drop-down list to view the display's current color calibration and evaluate the need for automatic module adjustment. Refer to **Figure 99**.
4. Click **Preview** to start the automatic calibration process. This can take a few seconds or a few minutes depending on the size of the display. A progress bar shows the status of the calibration process. Review the changes made to the display.
5. Click one or more of the following options after adjusting the modules:

- a. Click **Store** to save the newly changed calibration values.
- b. Click **Clear Preview** to clear the recently made changes (all changes made since the last **Store**).
- c. Click **Clear Stored** to delete the stored manual module calibration. If the display is camera calibrated, this will become the default, otherwise the settings will revert to the factory default.

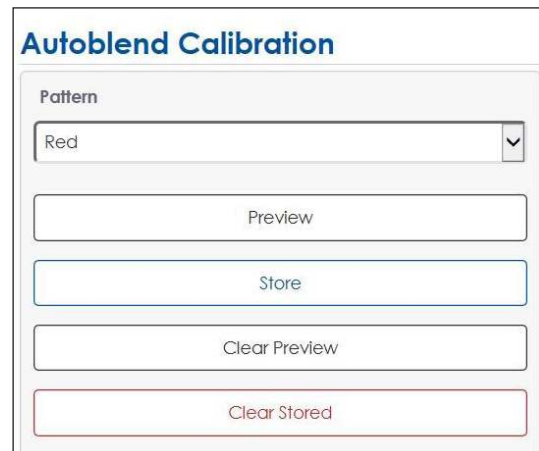

Figure 99: Output Color Patterns

Note: After clicking **Clear Stored**, a confirmation prompt opens since this action removes the stored manual calibration from the entire display. Press **Yes** to clear the manual calibration settings, or **No** to exit. Refer to **Figure 100**.

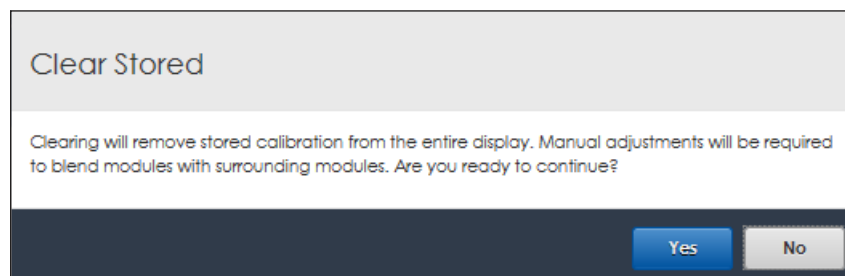



Figure 100: Clear Stored Calibration Settings

9 System Backup

Click **System Backup**  to open a window to manage system backups. The options are to either save the VIP's current system backup files or restore the current system to a previously saved backup file. Refer to **Figure 101**.

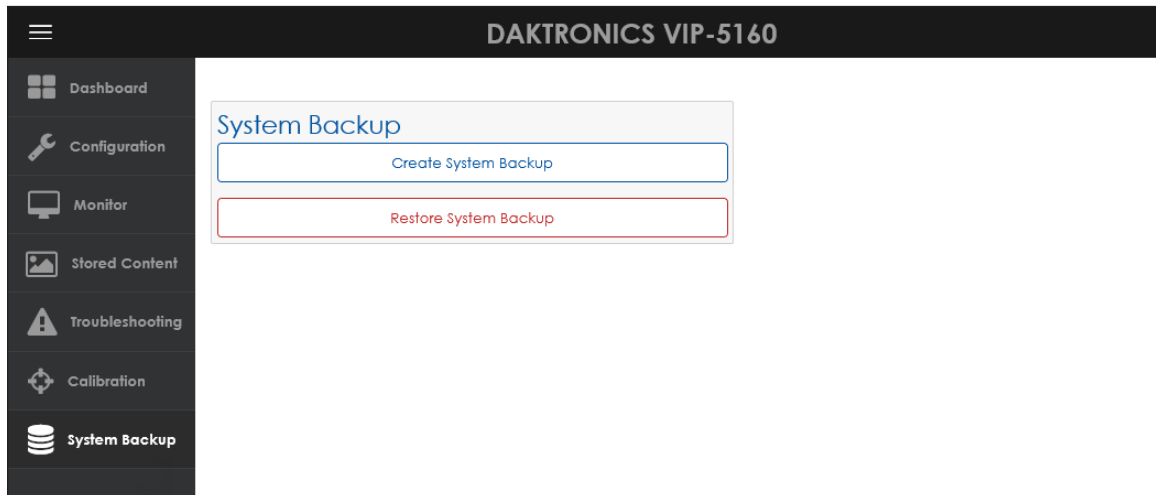

Figure 101: System Backup

Click **Create System Backup** to save the current system's configuration files and translation table. A prompt opens with options to open or save these files.

Click **Restore System Backup** to replace the current system's configuration files and translation table with previously saved versions. A prompt opens to confirm this action. Refer to **Figure 102**.

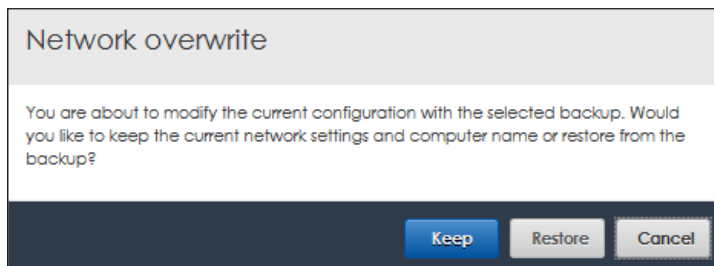

Figure 102: Restore System Backup Prompt

10 Exchange/Repair & Return Programs

To serve customers' repair and maintenance needs, Daktronics offers both an Exchange Program and a Repair & Return Program.

Exchange Program

Daktronics unique Exchange Program is a quick service for replacing key parts in need of repair. If a part requires repair or replacement, Daktronics sends the customer a replacement, and the customer sends the defective part to Daktronics. This decreases display downtime.

Before contacting Daktronics, identify these important part numbers:

Display Serial Number: _____

Display Model Number: _____

Contract Number: _____

Installation Date: _____

Sign Location: _____

Daktronics Customer ID Number: _____

To participate in the Exchange Program, follow these steps:

1. Call Daktronics Customer Service.

Market Description	Customer Service Number
Schools (primary through community/junior colleges, religious organizations, municipal clubs, and community centers)	877-605-1115
Universities and professional sporting events, live events for auditoriums, and arenas	866-343-6018
Financial institutions, petroleum, sign companies, gaming, and wholesale/retail establishments	866-343-3122
Department of Transportation, mass transits, airports, and parking facilities	800-833-3157

2. When the new exchange part is received, mail the old part to Daktronics.

If the replacement part fixes the problem, send in the problem part which is being replaced.

- a. Package the old part in the same shipping materials in which the replacement part arrived.
- b. Fill out and attach the enclosed UPS shipping document.
- c. Ship the part to Daktronics.

Daktronics will charge for the replacement part immediately, unless a qualifying service agreement is in place. In most cases, the replacement part will be invoiced at the time it is shipped.

- 3. Return the part within 30 working days if the replacement part does not solve the problem, or Daktronics will charge the full purchase price.**

If the part is still defective after the exchange is made, please contact Daktronics Customer Service immediately. Daktronics expects immediate return of an exchange part if it does not solve the problem. Daktronics also reserves the right to refuse parts that have been damaged due to acts of nature or causes other than normal wear and tear.

Repair & Return Program

For items not subject to exchange, Daktronics offers a Repair & Return Program. To send a part for repair, follow these steps:

- 1. Call Daktronics Customer Service.**

Refer to the telephone number listed on the previous page.

- 2. Receive a Return Materials Authorization (RMA) number before shipping.**

Refer to the telephone number listed on the previous page.

- 3. Package and pad the item carefully to prevent damage during shipping.**

Electronic components, such as printed circuit boards, should be placed in an antistatic bag before boxing. Daktronics does not recommend packing peanuts when shipping.

- 4. Enclose the following information:**

- Name
- Address
- Phone number
- RMA number
- Clear description of symptoms

Shipping Address

Daktronics Customer Service
600 E 54th St N
Sioux Falls, SD 57104
Case#

Warranty & Limitation of Liability

The Daktronics Warranty & Limitation of Liability statement is located in **Appendix B: Daktronics Warranty & Limitation of Liability (p.59)**. The warranty is independent of extended service agreements and is the authority in matters of service, repair, and display operation.

11 Glossary

Boot Loading: Process that allows changes to the firmware.

Brightness: Adjustment of the overall brightness or dimming of a sign. The brightness level should be highest during the day to compete with daylight and lower at night for comfortable viewing. Manual brightness adjustment is performed by the user; automatic brightness adjustment is performed by the software based on information received from a light sensor.

Calibration: Process of adjusting the intensity level of each pixel in a Daktronics LED video display as needed to improve the uniform intensity of the entire display.

CAN (Controller Area Network): Serial network of microcontrollers that enables real-time control applications by connecting devices and sensors.

LUX (Luxmeters): SI measurement of light intensity.

DHCP (Dynamic Host Configuration Protocol): System that includes a server that assigns IP addresses.

Firmware: Software (programs or data) that has been written onto read-only memory as a permanent part of a computing device. It allows software to be read and executed but does not allow modification. Firmware is embedded in a hardware device and is considered a combination of software and hardware.

Gamma: Process used with video images to correct brightness and internal micro-contrast within the image; it allows a change of ratio between the brightest red component and weakest red component.

NAT (Network Address Translation): Method for enabling private IP networks to connect to the internet.

RGB (Red-Green-Blue): Colors of LEDs used in full-color Daktronics displays. All colors are defined in terms of a combination of these three colors. For example, the RGB abbreviation for the color blue is 0-0-255.

Sensor Cable: Wire link between a controller and its corresponding temperature sensor.

SSL (Secure Sockets Layer): Standard technology used to keep an internet connection secure and protect the data sent between two systems.

Temperature Sensor: Outdoor electrical component used to detect the ambient air temperature outside a display.

VIP (Video Image Processor): Device primarily intended to accept and process live video and/or computer graphics feeds before sending them to a display.

Video Processor: Device used to input and output a number of signal types. It also applies video image enhancement tools.

V-Max™ Signal: Proprietary signal used with Daktronics displays.

VPMP (Video Processor Management Protocol): Device management protocol.

This page intentionally left blank.

A Supplementary Documents

This section includes the following:

- DisplayFind Utility Quick Guide (**DD1961783**)
- VIP-5000 Series Quick Guide (**DD2773153**)

This page intentionally left blank.

DisplayFind Utility

DisplayFind utility is used to find devices (including displays) on a local network when the IP address is unknown. The computer running the DisplayFind utility must be on the same subnet as the target device.

Downloading DisplayFind Utility

Download the application software from either the control software CD or from the internet. To download the DisplayFind file from the internet, follow these steps:

1. Open a web browser (i.e. Google Chrome® or Firefox® browser).
2. Go to <https://dakfiles.daktronics.com/>.
3. Click **Venus1500 > utils > DisplayFind > DisplayFind.exe**.
4. Click **Run** to download the DisplayFinder utility or **Save** to save the file to the computer for later use.

Launching DisplayFind Utility

The DisplayFind file automatically opens if **Run** was selected in Step 4 above.

If **Save** was selected instead of **Run**, locate where the DisplayFind.exe file was saved during download and double-click the icon to open the program. Refer to **Figure 1**.

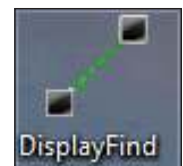

Figure 1: Icon

Configuring DisplayFind Utility

After launching the DisplayFind utility, review the list of associated items. The top two items in the list should have a green check mark ✓. Refer to **Figure 2**.

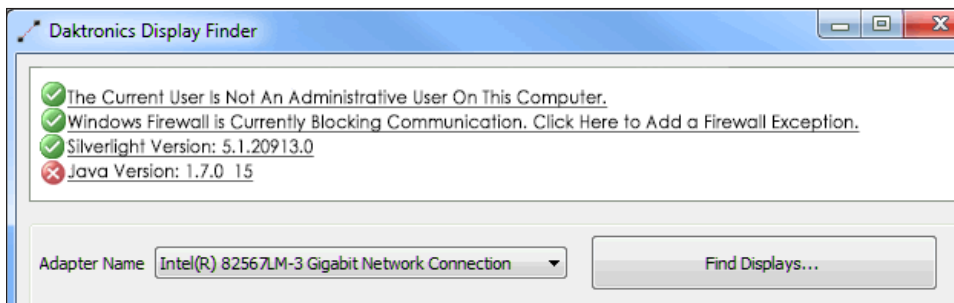

Figure 2: DisplayFind Utility Window

If one of the top two items has a red X ✗ next to it as shown in **Figure 3**, click it for additional information or to access the download.

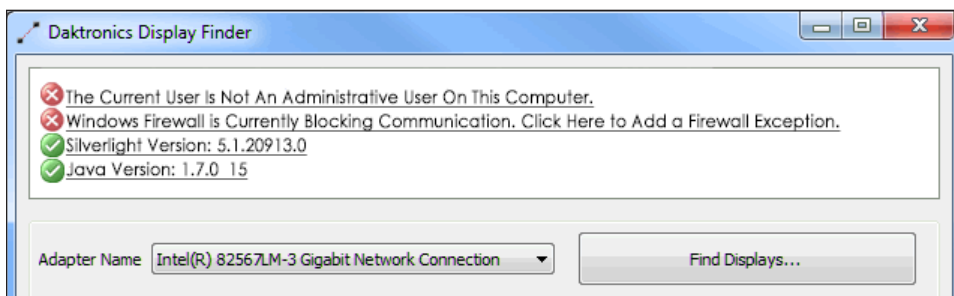

Figure 3: Errors

A red X ✗ next to **The Current User Is Not An Administrative User On This Computer** indicates that the user does not have administrative rights on the computer being used. After installation, administrative rights are no longer necessary.

A red X (✘) next to **Windows Firewall is Currently Blocking Communication** indicates that the Windows® firewall is not disabled. Temporarily disable the Windows® firewall to allow discovery responses to be received from any displays. Temporarily disable other third party anti-virus/firewall applications (i.e. McAfee®, Symantec®, ZoneAlarm® software etc.).

Note: Configure firewall exceptions to allow inbound TCP and UDP traffic on Port 3702 if temporarily disabling the firewall is not desired.

Ignore a red X (✘) next to **Silverlight Version** and **Java Version** as these programs are no longer required by the system.

If the connection is slow, increase the **Discovery Timeout** value by following these steps:

1. Click the **DisplayFind** icon  in the upper-left corner of the application header.
2. Click **Settings**. Refer to **Figure 4**.
3. Set a new **Discovery Timeout** using the up and down arrow buttons. Refer to **Figure 5**.
4. Click **OK**.

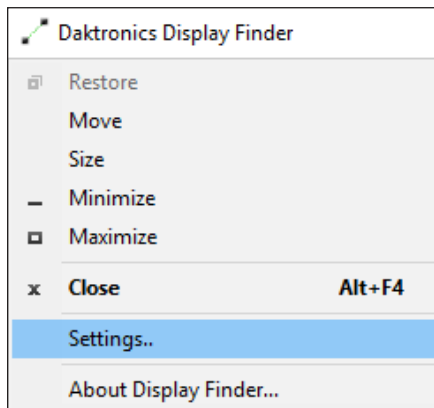

Figure 4: Display Finder Settings

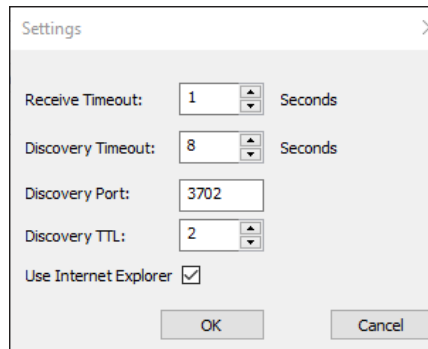

Figure 5: Discovery Timeout Settings

Connecting to a Device

Before connecting to the device, verify that the device is turned on and connected to the network currently in use. To connect to the device, follow these steps:

1. Select the correct network adapter used to communicate with the device from the **Adapter Name** drop-down list. Refer to **Figure 6**.



Figure 6: Network Adapter Name Selection

- Click **Find Displays** to detect any devices using the selected network adapter. Detected devices are listed in the bottom window of the utility. Refer to **Figure 7**.

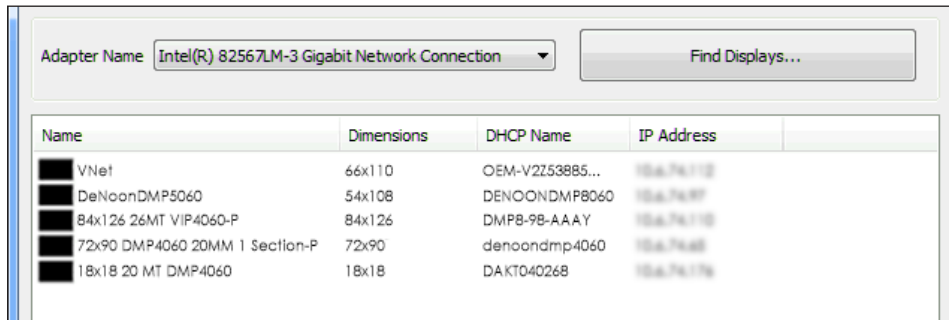

Figure 7: Detected Displays

- Double-click the desired device to launch the configuration utility within a web browser.

Note: If multiple components are found, identify the desired device by matching the **DHCP Name** to the sticker on the back of the device itself.

Troubleshooting

If the hardware and software are configured with a DMP behind a VIP running in NAT mode, the DisplayFind utility cannot detect the player. In this case, use the DisplayFind utility to find the VIP and then remove the **:85** port number from the address to access the player's UI.

Contact Info

If further assistance is required, contact Daktronics Customer Service via phone or online.

- Domestic (U.S. and Canada): 1-800-325-8766
- International: +1-605-697-4000
- www.daktronics.com

The VIP-5000 series processor is the interface that drives video to a digital display and meets operational needs such as dimming, displaying test patterns, and adjusting gamma and color controls.

VIP-5060 accepts standard DVI inputs of 800x600 and 1280x720. VIP-5160 accepts standard DVI inputs of 800x600 and 1280x720 but has an additional input resolution allowing 1440x900 DVI input with reduced blanking. This quick guide explains basic VIP-5000 series connections and setup as shown in **Figure 1**.

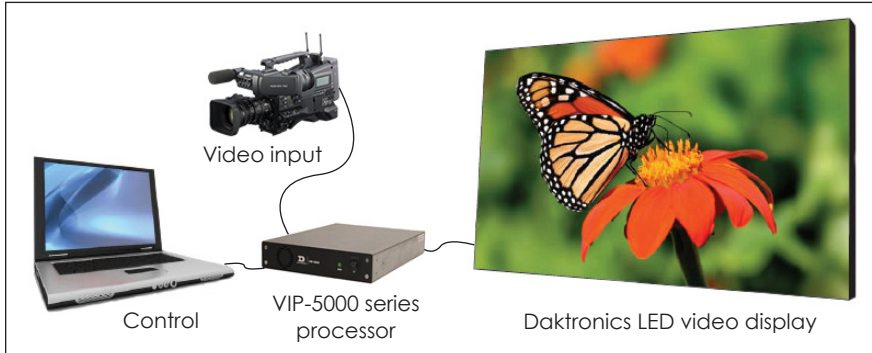

Figure 1: VIP-5000 Series Connections

Hardware Setup

Connecting to the LED Video Display

1. Locate fiber-optic Port A and Port B on the processor.
2. Insert duplex LC fiber-optic cables into their corresponding ports. The cables will click into place when seated properly. Refer to **Figure 2** and **Figure 3**.

Note: Remove fiber dust covers from cables and connectors prior to inserting into ports.



Figure 2: Display-Mount Fiber-Optic Port



Figure 3: Rack-Mount Fiber-Optic Ports

Connecting to the DVI Video Source

1. Insert the male plug into the female jack.
2. Turn the screws on the male plug clockwise to lock. Refer to **Figure 4** and **Figure 5**.



Figure 4: Display-Mount DVI Video Input Jack



Figure 5: Rack-Mount DVI Video Input Jack

Note: The processor supports a refresh rate of 60Hz and has a playback window at 0,0 (upper-left) of DVI input. The playback window matches the display size in pixels.

Connecting to the Network

1. Connect one end of the RJ45 network cable to the network port. Refer to **Figure 6** and **Figure 7**.

Note: For a display-mount system, rotate the connector $\frac{1}{4}$ turn clockwise to lock.

2. Connect the other end of the cable to the computer or network.



Figure 6: Display-Mount Network Port

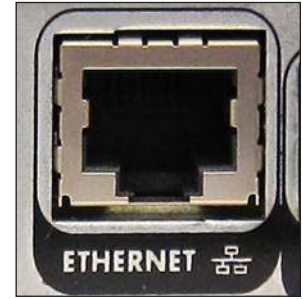

Figure 7: Rack-Mount Network Port

Connecting Power

Display-Mount Systems (12VDC)

1. Connect the breakout cable to the power/sensor port. Refer to **Figure 8**.
2. Rotate the connector $\frac{1}{4}$ turn clockwise to lock.
3. Connect the breakout cable to the power cord.
4. Terminate the cord at the display's power panel.



Figure 8: Display-Mount Power/Sensor Port



Figure 9: Rack-Mount Power Jack

Rack-Mount Systems (120/240VAC)

1. Connect the power cord to the power jack. Refer to **Figure 9**.
2. Plug the other end of the cord into an outlet.

Connecting Temperature/Light Sensors

Display-Mount Systems

1. Connect the sensor cable's M12 connector to the temperature/light port. Refer to **Figure 10**.
2. Turn the connector ring clockwise until tightened.

Rack-Mount Systems

Connect the sensor cable to the CAN port. Refer to **Figure 11**.



Figure 10: Display-Mount Sensor Port

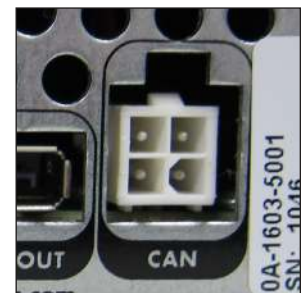

Figure 11: Rack-Mount Sensor Port

Computer-to-Processor Setup

Connecting to the Processor

1. Download the DisplayFind application from either the control software CD or the internet.
 - a. Navigate to **dakfiles.daktronics.com**.
 - b. Click **venus1500>Utils>DisplayFind>DisplayFind.exe**.
 - c. Click **Run** to download the program or **Save** to save the file for later use.

2. Launch the DisplayFind application by double-clicking the **DisplayFind** icon. Refer to **Figure 12**.
3. Connect to the display using the DisplayFind utility.
 - a. Select the appropriate **Network Adapter**.
 - b. Click **Find Displays** to detect displays. Refer to **Figure 13**.

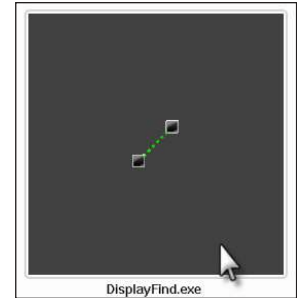

Figure 12: DisplayFind Icon

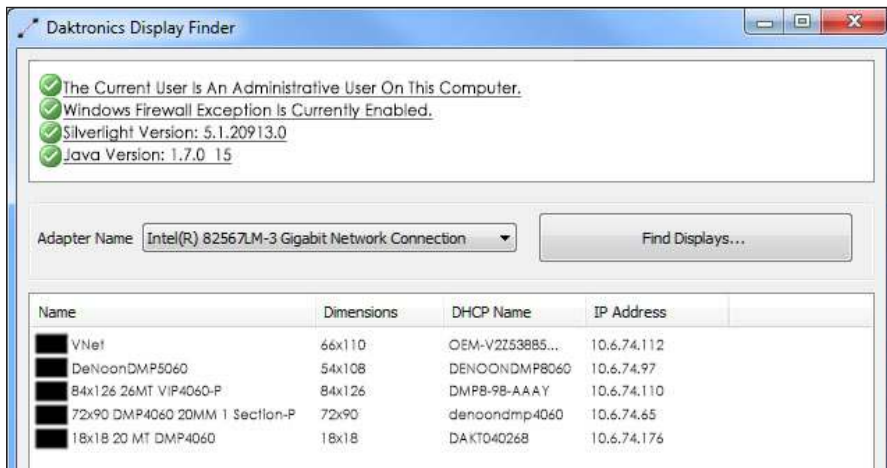

Figure 13: Daktronics DisplayFind Application

- c. Click the desired display to launch the configuration utility within a web browser.

Note: If multiple displays are found, use the IP address or name to confirm the identity of the correct display.

Logging in to the Processor

1. Navigate to **http://<IPaddress>:<Port>**. The port is typically **85**.
2. Type **Dak** into the **User name** text box. Refer to **Figure 14**.
3. Type **DakPassword!** into the **Password** text box.
4. Click **OK**.

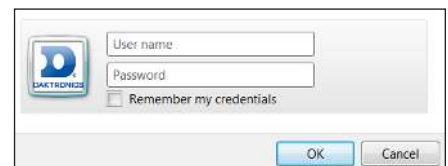

Figure 14: VIP-5000 Series Login

These are the factory-configured login credentials. *Daktronics strongly recommends changing the password after initial configuration.*

After setting a new password, this new password must be entered into the **Password** text box during login.







Note: Do not lose the password; losing it may require a service call.

Newer display-mount VIP-5160s have an internal reset switch that can be used to reset the password and/or configuration. Remove the switch cover to access the reset switch and press down for 5-15 seconds. The user name and password will revert to the factory-configured login credentials.

Note: Use caution when using an internal reset switch. Pressing the switch for longer than 15 seconds can reset the configuration.

Processor Menu Overview

After initial login, the **Dashboard** window opens showing status tiles for various aspects of the device. Click the **Show Menu** icon  in the upper-left corner to expand the main menu. Refer to the table below. For more information, refer to the **VIP-5000 Series Operation Manual (DD2773153)**.

Menu Item	Description
 Dashboard	Shows status tiles for various aspects of the processor; most tiles trigger operational windows but some tiles only provide information
 Configuration	Lists all available configuration settings and tools including setting the input, output, brightness levels, local time, and location
 Monitor	Opens a window showing a video feed of the display content
 Stored Content	Shows existing stored content files and allows images to be added or removed
 Troubleshooting	Lists troubleshooting options including testing, resetting power, and resetting the processor
 Calibration	Lists calibration tools used to adjust individual modules to blend with surrounding modules
 System Backup	Lists system backup options including creating a system backup and restoring a system backup

System Configuration

Configuring Input

Select the processor’s type of input including selecting a DVI video source, choosing a built-in test pattern, loading static images, or blanking the display. Refer to **Figure 15**. To configure the processor for a DVI video source, follow the steps below:

1. Select **Configuration** from the main menu or click the **Input** tile on the dashboard.
2. Click **Input**.
3. Choose **DVI** from the **Display Mode** drop-down list.
4. Change the **Color Adjustment** settings of the DVI video signal with the **Brightness**, **Contrast**, **Saturation**, and **Hue** slider bars if desired.
5. Set the **Source Dimensions** as either **Automatic** or **Manual** to define what portion of the incoming video signal is shown on the display. This setting is normally determined at the factory.
 - **Automatic** - the controller positions the content and the dimensions will match the configured display size.
 - **Manual** - the operator manually defines the visible area.

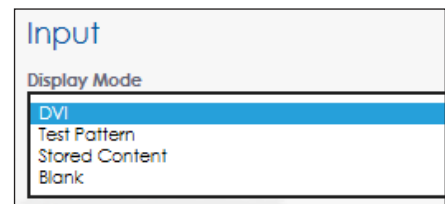

Figure 15: Input Display Mode

- Set the **Target Dimensions** as either **Automatic** or **Manual** to position the incoming video signal on the display. *This feature should not be used unless instructed to do so by Daktronics technicians.*
 - Automatic** - the controller positions the content and the dimensions will match the configured display size.
 - Manual** - the operator manually defines the content placement and positioning.
- Click **Save**.

Configuring Output

Set the display output as either **Active** or **Inactive**. If the processor system is the primary system, the **Output State** should be set as **Active**. If the processor system is the backup system, the **Output State** should be set as **Inactive**. Refer to **Figure 16**. To configure the output, follow the steps below:

- Select **Configuration** from the main menu.
- Click **Output**.
- Choose the **Output State** as **Active** or **Inactive**. If **Inactive** is selected, proceed to Step 8.
- Select the **Boot Sequence** from the drop-down list to choose what is shown during display startup.
 - Full** - shows full display information (description, dimensions, time zone etc.)
 - Compact** - shows product and version information
 - None** - shows no information, playback starts immediately
- Adjust the **Green Mode** percentage to set a threshold for dimming the display content.
- Adjust the **Gamma** number to adjust the middle ranges of color.
- Choose the **Color Space** setting from the drop-down list.
- Click **Save**.

The screenshot shows the 'Output' configuration page. At the top, 'Output State' has two buttons: 'Active' (selected) and 'Inactive'. Below that is a 'Boot Sequence' dropdown menu set to 'None'. The 'Green Mode (%)' section has a text input '100' and a slider bar. The 'Gamma' section has a text input '2.2' and a slider bar. The 'Color Space' section has a dropdown menu set to 'Disabled'.

Figure 16: Configuring Output

Configuring Brightness

To adjust display brightness, refer to **Figure 17** and follow the steps below:

- Select **Configuration** from the main menu.
- Click **Brightness**.
- Select the **Mode** from the drop-down list.
 - Automatic** – brightness values adjust according to data received from a light sensor.
 - Manual** – brightness values are set at a constant level using a slider bar.
 - Remote** – dimming values are determined by a host processor in a multi-VIP host-client system.

The screenshot shows the 'Brightness' configuration page. At the top, 'Mode' is a dropdown menu set to 'Automatic'. Below that is the 'Brightness Limits' section. Under 'Set Brightness Settings', there are two buttons: 'All Day' (selected) and 'Day and Night'. The 'Minimum Brightness (%)' section has a text input '4' and a slider bar. The 'Maximum Brightness (%)' section has a text input '75' and a slider bar.

Figure 17: Configuring Brightness

4. Choose either **All Day** or **Day and Night** under **Set Brightness Settings**.

- **All Day** - sets display minimum and maximum brightness for a 24-hour period.
- **Day and Night** - sets display minimum and maximum brightness based on the time of day.

Contact Info and Where to Get Help

Click **Help** under the **User** icon  in the upper-right corner of the screen to access the **VIP-5000 Series Video Image Processor Operation Manual (DD2773152)**.

Click **About** under the **User** icon  in the upper-right corner of the screen to access the Daktronics website. Refer to **Figure 18**.

If further assistance is required, Daktronics Customer Service is available 24/7 via phone or online.

Telephone

- Domestic (U.S. and Canada): 1-800-325-8766
- International: +1-605-697-4000

Online

- www.daktronics.com/support



DAKTRONICS VIP-5160

Copyright © 2016, Daktronics, Inc
Visit us at: <http://www.Daktronics.com>

For support information
Call: 1-800-DAKTRONICS

[Open Source attributions](#)

VIP Version Information

Web	2.3.241
User Agent	Mozilla/5.0 (Windows NT 6.1; WOW64) AppleWebKit/537.36 (KHTML, like Gecko) Chrome/56.0.2924.87 Safari/537.36

Figure 18: Contact Information

B Daktronics Warranty & Limitation of Liability

This section includes the Daktronics Warranty & Limitation of Liability statement.

This page intentionally left blank.

DAKTRONICS WARRANTY & LIMITATION OF LIABILITY

This Warranty and Limitation of Liability (the “Warranty”) sets forth the warranty provided by Daktronics with respect to the Equipment. By accepting delivery of the Equipment, Purchaser and End User agree to be bound by and accept these terms and conditions. Unless otherwise defined herein, all terms within the Warranty shall have the same meaning and definition as provided elsewhere in the Agreement.

DAKTRONICS WILL ONLY BE OBLIGATED TO HONOR THE WARRANTY SET FORTH IN THESE TERMS AND CONDITIONS UPON RECEIPT OF FULL PAYMENT FOR THE EQUIPMENT

1. Warranty Coverage.

- A. Daktronics warrants to the original end user (the “End User”, which may also be the Purchaser) that the Equipment will be free from Defects (as defined below) in materials and workmanship for a period of one (1) year (the “Warranty Period”). The Warranty Period shall commence on the earlier of: (i) four weeks from the date that the Equipment leaves Daktronics’ facility; or (ii) Substantial Completion as defined herein. The Warranty Period shall expire on the first anniversary of the commencement date.

“Substantial Completion” means the operational availability of the Equipment to the End User in accordance with the Equipment’s specifications, without regard to punch-list items, or other non-substantial items which do not affect the operation of the Equipment
- B. Daktronics’ obligation under this Warranty is limited to, at Daktronics’ option, replacing or repairing, any Equipment or part thereof that is found by Daktronics not to conform to the Equipment’s specifications. Unless otherwise directed by Daktronics, any defective part or component shall be returned to Daktronics for repair or replacement. This Warranty does not include on-site labor charges to remove or install these components. Daktronics may, at its option, provide on-site warranty service. Daktronics shall have a reasonable period of time to make such replacements or repairs and all labor associated therewith shall be performed during regular working hours. Regular working hours are Monday through Friday between 8:00 a.m. and 5:00 p.m. at the location where labor is performed, excluding any holidays observed by Daktronics.
- C. Daktronics shall pay ground transportation charges for the return of any defective component of the Equipment. All such items shall be shipped by End User DDP Daktronics designated facility per Incoterms® 2020. If returned Equipment is repaired or replaced under the terms of this Warranty, Daktronics will prepay ground transportation charges back to End User and shall ship such items DDP End User’s designated facility per Incoterms® 2020; otherwise, End User shall pay transportation charges to return the Equipment back to the End User and such Equipment shall be shipped Ex Works Daktronics designated facility per Incoterms® 2020. All returns must be pre-approved by Daktronics before shipment. Daktronics shall not be obligated to pay freight for any unapproved return. End User shall pay any upgraded or expedited transportation charges
- D. Any replacement parts or Equipment will be new or serviceably used, comparable in function and performance to the original part or Equipment and warranted for the remainder of the Warranty Period. Purchasing additional parts or Equipment from the Seller does not extend the Warranty Period.
- E. Defects shall be defined as follows. With regard to the Equipment (excepting LEDs), a “Defect” shall refer to a material variance from the design specifications that prohibit the Equipment from operating for its intended use. With respect to LEDs, “Defects” are defined as LED pixels that cease to emit light. Unless otherwise expressly provided, this Warranty does not impose any duty or liability upon Daktronics for partial LED pixel degradation. Notwithstanding the foregoing, in no event does this Warranty include LED pixel degradation caused by UV light. This Warranty does not provide for the replacement or installation of communication methods including but not limited to, wire, fiber optic cable, conduit, trenching, or for the purpose of overcoming local site interference radio equipment substitutions.

EXCEPT AS OTHERWISE EXPRESSLY SET FORTH IN THIS WARRANTY, TO THE MAXIMUM EXTENT PERMITTED BY APPLICABLE LAW, DAKTRONICS DISCLAIMS ANY AND ALL OTHER PROMISES, REPRESENTATIONS AND WARRANTIES APPLICABLE TO THE EQUIPMENT AND REPLACES ALL OTHER WARRANTIES OR CONDITIONS, EXPRESS OR IMPLIED, INCLUDING, BUT NOT LIMITED TO, ANY IMPLIED WARRANTIES OR CONDITIONS OF MERCHANTABILITY, FITNESS FOR A PARTICULAR PURPOSE, OR ACCURACY OR QUALITY OF DATA. OTHER ORAL OR WRITTEN INFORMATION OR ADVICE GIVEN BY DAKTRONICS, ITS AGENTS OR EMPLOYEES, SHALL NOT CREATE A WARRANTY OR IN ANY WAY INCREASE THE SCOPE OF THIS LIMITED WARRANTY.

THIS LIMITED WARRANTY IS NOT TRANSFERABLE.

2. Exclusion from Warranty Coverage

This Warranty does not impose any duty or liability upon Daktronics for any:

- A. damage occurring at any time, during shipment of Equipment unless otherwise provided for in the Agreement. When returning Equipment to Daktronics for repair or replacement, End User assumes all risk of loss or damage, agrees to use any shipping containers that might be provided by Daktronics, and to ship the Equipment in the manner prescribed by Daktronics;
- B. damage caused by: (i) the improper handling, installation, adjustment, use, repair, or service of the Equipment, or (ii) any physical damage which includes, but is not limited to, missing, broken, or cracked components resulting from non-electrical causes;



DAKTRONICS WARRANTY & LIMITATION OF LIABILITY

altered, scratched, or fractured electronic traces; missing or gauged solder pads; cuts or clipped wires; crushed, cracked, punctured, or bent circuit boards; or tampering with any electronic connections, provided that such damage is not caused by personnel of Daktronics or its authorized repair agents;

- C. damage caused by the failure to provide a continuously suitable environment, including, but not limited to: (i) neglect or misuse; (ii) improper power including, without limitation, a failure or sudden surge of electrical power; (iii) improper air conditioning, humidity control, or other environmental conditions outside of the Equipment's technical specifications such as extreme temperatures, corrosives and metallic pollutants; or (iv) any other cause other than ordinary use;
- D. damage caused by fire, flood, earthquake, water, wind, lightning or other natural disaster, strike, inability to obtain materials or utilities, war, terrorism, civil disturbance, or any other cause beyond Daktronics' reasonable control;
- E. failure to adjust, repair or replace any item of Equipment if it would be impractical for Daktronics personnel to do so because of connection of the Equipment by mechanical or electrical means to another device not supplied by Daktronics, or the existence of general environmental conditions at the site that pose a danger to Daktronics personnel;
- F. statements made about the product by any salesperson, dealer, distributor or agent, unless such statements are in a written document signed by an officer of Daktronics. Such statements as are not included in a signed writing do not constitute warranties, shall not be relied upon by End User and are not part of the contract of sale;
- G. damage arising from the use of Daktronics products in any application other than the commercial and industrial applications for which they are intended, unless, upon request, such use is specifically approved in writing by Daktronics;
- H. replenishment of spare parts. In the event the Equipment was purchased with a spare parts package, the parties acknowledge and agree that the spare parts package is designed to exhaust over the life of the Equipment, and as such, the replenishment of the spare parts package is not included in the scope of this Warranty;
- I. security or functionality of the End User's network or systems, or anti-virus software updates;
- J. performance of preventive maintenance;
- K. third-party systems and other ancillary equipment, including without limitation front-end video control systems, audio systems, video processors and players, HVAC equipment, batteries and LCD screens;
- L. incorporation of accessories, attachments, software or other devices not furnished by Daktronics; or
- M. paint or refinishing the Equipment or furnishing material for this purpose.

3. Limitation of Liability

- A. Daktronics shall be under no obligation to furnish continued service under this Warranty if alterations are made to the Equipment without the prior written approval of Daktronics.
- B. It is specifically agreed that the price of the Equipment is based upon the following limitation of liability. In no event shall Daktronics (including its subsidiaries, affiliates, officers, directors, employees, or agents) be liable for any claims asserting or based on (a) loss of use of the facility or equipment; lost business, revenues, or profits; loss of goodwill; failure or increased cost of operations; loss, damage or corruption of data; loss resulting from system or service failure, malfunction, incompatibility, or breaches in system security; or (b) any special, consequential, incidental or exemplary damages arising out of or in any way connected with the Equipment or otherwise, including but not limited to damages for lost profits, cost of substitute or replacement equipment, down time, injury to property or any damages or sums paid to third parties, even if Daktronics has been advised of the possibility of such damages. The foregoing limitation of liability shall apply whether any claim is based upon principles of contract, tort or statutory duty, principles of indemnity or contribution, or otherwise
- C. In no event shall Daktronics be liable for loss, damage, or injury of any kind or nature arising out of or in connection with this Warranty in excess of the Purchase Price of the Equipment. The End User's remedy in any dispute under this Warranty shall be ultimately limited to the Purchase Price of the Equipment to the extent the Purchase Price has been paid.

4. Assignment of Rights

- A. The Warranty contained herein extends only to the End User (which may be the Purchaser) of the Equipment and no attempt to extend the Warranty to any subsequent user-transferee of the Equipment shall be valid or enforceable without the express written consent of Daktronics.

5. Governing Law; Election of Remedies

- A. The rights and obligations of the parties under this Warranty shall not be governed by the provisions of the United Nations Convention on Contracts for the International Sales of Goods of 1980. The parties consent to the application of the laws of the State of South Dakota to govern, interpret, and enforce each of the parties' rights, duties, and obligations arising from, or relating in any manner to, the subject matter of this Warranty, without regard to conflict of law principles.
- B. Any dispute, controversy or claim arising from or related to this Warranty, the parties shall first attempt to settle through negotiations. In the event that no resolution is reached, then such dispute, controversy, or claim shall be resolved by final and binding arbitration under the Rules of Arbitration of the International Chamber of Commerce. The language of the arbitration



DAKTRONICS WARRANTY & LIMITATION OF LIABILITY

shall be English. The place of the arbitration shall be Sioux Falls, SD. A single arbitrator selected by the parties shall preside over the proceeding. If a single arbitrator cannot be agreed upon by the parties, each party shall select an arbitrator, and those arbitrators shall confer and agree on the appointed arbitrator to adjudicate the arbitration. The arbitrator shall have the power to grant any provisional or final remedy or relief that it deems appropriate, including conservatory measures and an award of attorneys' fees. The arbitrator shall make its decisions in accordance with applicable law. By agreeing to arbitration, the Parties do not intend to deprive any court of its jurisdiction to issue a pre-arbitral injunction, pre-arbitral attachment, or other order in aid of arbitration proceedings and the enforcement of any award. Without prejudice to such provisional remedies as may be available under the jurisdiction of a court, the arbitrator shall have full authority to grant provisional remedies and to direct the Parties to request that any court modify or vacate any temporary or preliminary relief issued by such court, and to award damages for the failure of any Party to respect the arbitrator's orders to that effect.

6. Availability of Extended Service Agreement

- A. For End User's protection, in addition to that afforded by the warranties set forth herein, End User may purchase extended warranty services to cover the Equipment. The Extended Service Agreement, available from Daktronics, provides for electronic parts repair and/or on-site labor for an extended period from the date of expiration of this warranty. Alternatively, an Extended Service Agreement may be purchased in conjunction with this Warranty for extended additional services. For further information, contact Daktronics Customer Service at 1-800-DAKTRONics (1-800-325-8766).

Additional Terms applicable to sales outside of the United States

The following additional terms apply **only** where the installation site of the Equipment is located outside of the United States of America.

1. In the event that the installation site of the Equipment is in a country other than the U.S.A., then, notwithstanding Section 5 of the Warranty, where the selling entity is the entity listed in Column 1, then the governing law of this Warranty is the law of the jurisdiction listed in the corresponding row in Column 2 without regard to its conflict of law principles. Furthermore, if the selling entity is an entity listed in Column 1, then the place of arbitration is listed in the corresponding row in Column 3.

Column 1 (Selling Entity)	Column 2 (Governing Law)	Column 3 (Location of Arbitration)
Daktronics, Inc.	The state of Illinois	Chicago, IL, U.S.A.
Daktronics Canada, Inc.	The Province of Ontario, Canada	Toronto, Ontario, Canada
Daktronics UK Ltd.	England and Wales	Bristol, UK
Daktronics GmbH	The Federal Republic of Germany	Wiesbaden, Germany
Daktronics Hong Kong Limited	Hong Kong, Special Administrative Region of the P.R.C.	Hong Kong SAR
Daktronics Shanghai Co., Ltd.	The Peoples Republic of China	Shanghai, P.R.C.
Daktronics France, SARL	France	Paris, France
Daktronics Japan, Inc.	Japan	Tokyo, Japan
Daktronics International Limited	Macau, Special Administrative Region of the P.R.C.	Macau SAR
Daktronics Australia Pad Ltd	Australia	Sydney, Australia
Daktronics Singapore Pte. Ltd	Singapore	Singapore
Daktronics Brazil LTDA	Brazil	São Paulo, Brazil
Daktronics Spain S.L.U.	Spain	Madrid, Spain
Daktronics Belgium N. V	Belgium	Kruikebeke, Belgium
Daktronics Ireland Co. Ltd.	Ireland	Dublin, Ireland

